



**Ersatzteilkatalog
Spare Parts Catalogue
2023**

Inhalt / List of contents



Baustellengeräte / Site Equipment

1	Pflasterverlegung und Pflastertransport Paver Laying and Transportation	5
2	Pflasterverfugung und Reinigung Joint Filling and Surface Cleaning	33
3	Planumserstellung Screeding	39
4	Profi-Werkzeuge Professional Tools	47
5	Vakuumverlegung Vacuum Laying	57
6	Verlegung Galabaulemente Laying of Landscaping Elements	109
7	Handling Betonschutzwände Handling of Concrete Barriers	135
8	Tiefbau: Ring- und Rohrverlegung Civil Engineering: Manhole and Pipe Laying	137
9	Hochbau- und Dachdeckergeräte Highrise and Roof Elements	145
	After Sales / Gewährleistung	148
	After Sales / Warranties	149
	Ersatzteil-Anfrageformular	150
	Spare Parts Request Form	151
	Liefer- und Zahlungsbedingungen	152
	General Sales Conditions	154

making hard work easier

**Wir sind die erste Adresse für
modernes Baustoff-Handling
und machen damit schwere
Arbeit leichter.**

**We are the top address for
modern building material
handling, making hard work
easier.**



Seit über 60 Jahren machen unsere Werkzeuge und Maschinen Ihren Baustellenalltag leichter. Durch viele wichtige ergonomische und effizienz-steigernde Innovationen sind wir heute Weltmarktführer und setzen die Standards im Baustoff-Handling auf Baustellen und in Betonwerken.

Unsere über 180 Mitarbeiter finden für Sie täglich die optimale Lösung – weltweit an unseren Standorten in Deutschland, Großbritannien, Frankreich, Italien, Polen, China, Korea, Kanada, USA und in Australien. Mit mehr als 1.400 Vertriebspartnern weltweit, davon über 700 in Deutschland, haben Sie überall einen kompetenten Partner an Ihrer Seite.

Seit 2020 ist die gesamte Unternehmensgruppe klimaneutral.

For over 60 years, our tools and machines have been making your everyday work on the construction site easier. Thanks to many important ergonomic and efficiency-enhancing innovations, we are now the world market leader and set the standards in building materials handling on construction sites and in concrete plants.

Our more than 180 employees find the optimal solution for you every day – worldwide at our locations in Germany, Great Britain, France, Italy, Poland, China, Korea, Canada, USA and in Australia. With more than 1,400 sales partners worldwide, including over 700 in Germany, you have a competent partner at your side wherever you are.

Since 2020, the entire group of companies has been climate-neutral.



1400

Vertriebspartner
weltweit /
Sales partner
worldwide

180

Mitarbeiter
weltweit /
Employees
worldwide

11

Niederlassungen
weltweit /
Subsidiaries
worldwide



**ENVIRONMENTAL
TECHNOLOGY AWARD**
BADEN-WÜRTTEMBERG 2021
3RD PRIZE
CATEGORY 3
EMISSION REDUCTION,
TREATMENT & SEPARATION

Service / After Sales Leistungen – After Sales Services



Technischer Support und Beratung
Technical support and consultancy



Ersatzteilservice
Spare parts service



Kundendienst/Wartung & DGUV Prüfung
vor Ort + im Werk
Customer service/ maintenance & DGUV testing
on site + at our factory



Schulung und Einweisung vor Ort + im Werk
Courses and briefing on site + at our factory



Wartungsvertrag, individuell konfigurierbar
Maintenance contract, individually configurable



Garantieabwicklung & Abholservice
Warranty processing & Collection service

**Aus Deutschland erreichen Sie
unser Team wie folgt:**



+ 49 7144 3309-10



+ 49 176 43818017



service@probst-handling.de

**You can contact our team from
abroad as follows:**



+ 49 7144 3309-30



+ 49 7144 3309-30



service@probst-handling.de





Allgemeine Ersatzteile für Verlegemaschinen VM Basic Spare Parts for Installation Machines VM

Artikel / Article	Beschreibung / Description	Best.-Nr. / Order-Number
Radnabe Wheel hub 	Radnabe vormontiert mit Radbolzen M12 x 1,5 / 35 lang Wheel hub preassembled with wheel bolts M12 x 1.5 / 35 long	41500500
Rad komplett Complete wheel 	Rad komplett 23 x 8, 5-12 10PR Complete wheel 23 x 8.5-12 10PR Kenda K500	21850018
Felge Rim 	Felge für VM Rad 7.00-12 Stahlfelge Rim for VM wheel 7.00-12 steel rim	21880001
Reifen Wheel 	Decke für VM-Rad 23 x 8.50-12 Casing for VM wheel 23 x 8.50-12; 4 PR Multi, Multi Tractl DICO	21850004
Radmotor Wheel engine 	Radmotor für Verlegemaschine Wheel engine for laying machine	41500589
HD Fußplattenventil HD base plate valve 	HD Fußplattenventil HD base plate valve	32030002
Einstellschraube Adjusting screw 	Einstellschraube zu HD Fußplattenventil (Bedarf: 2 Stück) Adjusting screw for HD base plate valve (requirement: 2 units)	20090027
Kolbenstift Piston pin 	Führungsbuchse inkl. Kolbenstift zu HD Fußplattenventil (Bedarf: 2 Stück) Guide bush incl. piston pin for HD base plate valve (requirement: 2 units)	22090017
Batterie Hauptschalter Battery master switch 	Natoknochen Schalter für KFZ Elektrik Master switch for vehicle electrics	24110009
Rückspiegel Rear-view mirror 	Rückspiegel Hella Hella rear-view mirror	41500286
Dichtsatz Seal kit 	Dichtsatz für Lenkzylinder Seal kit for steering cylinder	21510007



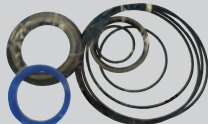

Allgemeine Ersatzteile für Verlegemaschinen VM Basic Spare Parts for Installation Machines VM

Artikel / Article	Beschreibung / Description	Best.-Nr. / Order-Number
Dichtsatz Seal kit	 Dichtsatz für Hubzylinder Seal kit for lifting cylinder	21510032
Dichtsatz Seal kit	 für Radmotor OMSW 315 (Typ 151 F 0534) for wheel motor OMSW 315 (type 151 F 0534)	21510052
Handgashebel Hand throttle	 Handgashebel Standard (außer VM-301-K) Hand throttle standard	21600003
Außenspiegel Exterior mirror	 Außenspiegel Exterior mirror VM203/204/301/VM-X	41500223

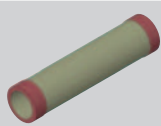

Verlegemaschine / Installation machine VM-X-PAVERMAX

Artikel / Article	Beschreibung / Description	Best.-Nr. / Order-Number
Kraftstoffpumpe Fuel pump	 Kraftstoffpumpe für Motor V1505 Fuel pump for motor V1505	26120005
Filter Filter	 Sicherheitspatrone für Luftfilter Safety cartridge for air filter	25000019
Keilriemen V-Belt	 Für Kubota V1505 V-Belt Kubota V1505	21100100









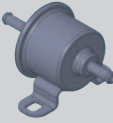

Verlegemaschine / Installation machine VM-X-PAVERMAX

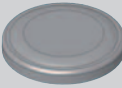
Artikel / Article	Beschreibung / Description	Best.-Nr. / Order-Number
Ventildeckeldichtung Valve cover seal	 Ventildeckeldichtung, Kopfdeckel Valve cover seal head cover	21590073
Dichtring Seal ring	 Dichtring für Ventildeckel (Bedarf 4Stück) Seal ring cover seal (4pc required)	26150008
Scheibenwischer Windscreen wiper	 Scheibenwischer oben oder unten Windscreen wiper top/bottom	26810015
Sicherungsstift Safety pin	 Sicherung für Fensteraufsteller Safety pin for window	21650036
Entlüftungsfiter Vent filter	 Tankentlüftung Vent filter tank	26900002
Lenkungsbolzen Steering bolt	 Bolzen für Lenkung Bolt for steering	30330064
Lenkungslager Steering bearing	 Kugelgelenk Lenkung Steering bearing	21440011
Motorlager Engine mounts	 Lagerung Motorblock Engine mounts	21070162
Wartungskit klein Maintenance kit small	 Alle Filter (außer Sicherheitspatrone) Maintenance kit small (without safety cartridge)	41501123
Wartungskit groß Maintenance kit large	 Bestehend aus Kit klein + Sicherheitspatrone + Keilriemen + Ventildeckeldichtung + Dichtringe Ventildeckel Maintenance kit large	41501124
Filterpatrone DPF Filter cartridge	 für Partikelfilter VM-X Cartridge for diesel particle filter DPF	26900060

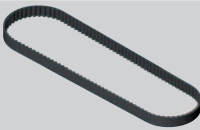

Verlegemaschine / Installation Machine VM-401

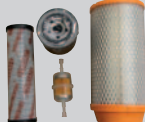
Artikel / Article	Beschreibung / Description	Best.-Nr. / Order-Number
CentaFlex-A-Kupplung CentaFlex-A-coupling	 Kupplung für Hydrostat V-450 Coupling for V-450 hydrostat	22020037
Kraftstoffpumpe Fuel pump	 Kraftstoffpumpe für Motor V1505 Fuel pump for engine V1505	26120005
Drehkopf Turning head	 Drehkopf Baltrotor Typ GR-10-02, Axiallast 1t Baltrotor turning head of type GR-10-02, axial load 1t	22500032
Tankverschluß Tank cap	 Tankverschluß RV160/60A tank cap	41500035
Edelstahlschlauch Auspuff Stainless steel hose exhaust	 Auspuff ohne Partikelfilter 420 mm lang. DN 35mm Exhaust without particelfilter 420 mm long. DN 35mm	41500327
Kühlwasserschlauch Coolant hose	 Kühlwasserschlauch Meterware NW31,5R NW 31.5 coolant hose by meter	26920016
Sitzkissen mit Stoffbezug Seat cushion with fabric cover	 Sitzkissen schwarz für Fahrersitz Black seat cushion for driver's seat	41500516
Zahnriemen kurz Cam belt short	 Zahnriemen Powergrip GT3 System ohne Spannrolle Zz 115 8M V-belt powergrip GT3 System without tension roller Zz 115	21110044
Zahnriemen lang Cam belt long	 Zahnriemen Powergrip GT3 (Ab P04A153) System mit Spannrolle Zz 120 8M V-belt powergrip GT3 System with tension roller Zz 120	21110046
Wartungskit VM-401, klein Maintenance kit VM-401, Small	 Set bestehend aus: Kraftstoffvorfilter, Motoröl Filter, Luftfilter Einsatz, Rücklaufsaugfilter Set includes: fuel prefilter, engine oil filter, air filter insert, return suction filter	41500770

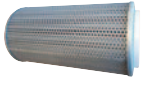

Verlegemaschine / Installation Machine VM-401

Artikel / Article	Beschreibung / Description	Best.-Nr. / Order-Number
Wartungskit VM-401, groß, bis FG: P04 A 152 Maintenance kit VM-401, Large, to FG: P04 A 152 	Bestehend aus: Kit klein + Kraftstofffilter, Luftfilter-Sicherheitspatrone, Hydraulikölfilter, Keilriemen, Zahnriemen Zz 115, Ventildeckeldichtung, Dichtringe Ventildeckel Includes: Small kit + fuel filter, air filter safety cartridge, hydraulic oil filter, V-belt, cam belt Zz 115, head gasket, valve cover sealing rings	41500872
Wartungskit VM-401, groß, ab FG: P04 A 153 Maintenance kit VM-401, Large, from FG: P04 A 153 	Bestehend aus: Kit klein + Kraftstofffilter, Luftfilter-Sicherheitspatrone, Hydraulikölfilter, Keilriemen, Zahnriemen Zz 120, Ventildeckeldichtung, Dichtringe Ventildeckel Includes: small kit + fuel filter, air filter safety cartridge, hydraulic oil filter, V-belt, cam belt Zz 120, head gasket, valve cover sealing rings	41500873
Filter 	Sicherheitspatrone für Luftfilter Safety cartridge for air filter	25000019
Keilriemen V-belt 	Keilriemen 10 x 950 V-belt 10 x 950	21100005
Ventildeckeldichtung Valve cover seal 	Ventildeckeldichtung, Kopfdeckel Valve cover seal, head cover	21590073
Dichtring Seal ring 	Dichtring für Ventildeckelschrauben (Bedarf: 4 Stück) Seal ring valve cover screw (4 pc. required)	26150008
Filterpatrone Filter cartridge 	für Dieselpartikelfilter DPF cartridge for diesel particle filter DPF	26900034
Lenkungsbolzen Steering bolt 	Lenkungsbolzen mit Verdrehsicherung (Bedarf: 4 Stück) Steering bolt with anti-twist protection (requirement: 4 units)	30330064
Lenkungsbuchse (DU Buchse) Steering bush (DU bush) 	Gleitlager Lenkungsbolzen 20 x 23 x 20 (Bedarf: 4 Stück) For steering bolt 26 x 20 x 20 (requirement: 4 units)	21400025





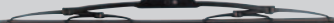

Verlegemaschine / Installation Machine VM-401

Artikel / Article	Beschreibung / Description	Best.-Nr. / Order-Number
Lenkungsbuchse Stahl Steering bush Steel 	Für Lenkungsbolzen 26 x 20 x 20 (Bedarf: 4 Stück) For steering bolt 26 x 20 x 20 (requirement: 4 units)	21460010
Scheibenwischer Windscreen wiper 	Scheibenwischerblatt Windscreen wiper blade	26810008

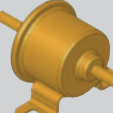

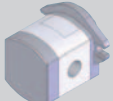
Verlegemaschinen / Installation Machines VM-203/204/301

Artikel / Article	Beschreibung / Description	Best.-Nr. / Order-Number
Viton-Tülle Tank Viton sleeve 	Viton-Tülle für Tank benzinfest VM-203/301 Petrol-resistant Viton sleeve for tank VM-203/301	26200001
Kraftstoffpumpe Electric fuel pump 	Kraftstoffpumpe für Kubota D1105 Fuel pump for Kubota D1105	26120002
Zahnradpumpe Gear pump 	Zahnradpumpe 2SPA11 bis FG V3-1271 ca. Nov. 2020 2SPA11 gear pump until FG V3-1271 approx. Nov. 2020	22600007
Zahnradpumpe Gear pump 	Zahnradpumpe ab FG V3-1272 ca. Dez. 2020 Gear pump from serial Nr. FG V3-1272 approx. Dec. 2020	22600095
Tankverschluß Tank cap 	Tankverschluß VM-203/301 Tank cap VM-203/301	41500035









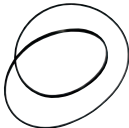

Verlegemaschinen / Installation Machines VM-203/204/301

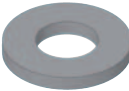
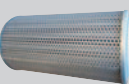
Artikel / Article	Beschreibung / Description	Best.-Nr. / Order-Number
Tankverschluß Tank cap	 Tankverschluß VM-204 Tank cap VM-204	26990016
Reparaturset Kreuzhebel Cross-lever repair kit	 Reparaturset für Kreuzhebel 2-fach Steuerventil VM-203/301 Repair kit for cross-lever 2-way control valve VM203/301	41600008
Drucktaster Push button	 Drucktaster Rafi für Drehkopf VM-203, VM-301 Rafi push button for VM-203, VM-301 turning head	24110025
Drehkopf Turning head	 Drehkopf Baltrotor Typ GR-10-02, Axiallast 1t Baltrotor turning head of type GR-10-02, axial load 1t	22500032
VM-Kugelgelenk VM ball joint	 Kugelgelenk, 20 x 1,5 - 18.1/20, für Lenkzylinder VM-203, 204, 301 Ball joint, 20 x 1.5 - 18.1/20, for VM steering cylinder	41500901
Umbausatz von DK Bini auf DK Baltrotor für VM-203/204 Conversion kit from DK Bini to DK Baltrotor for VM-203/204	 Umbausatz komplett inkl. Drehkopf für Doppelknick Ausleger Complete conversion kit incl. hydraulic rotator for double-bend boom	41500845
Dichtsatz Seal set	 kpl. für BINI, T1, 300°, 1 t complete for BINI, T1, 300°, 1 t	21510044
Filter	 Sicherheitspatrone für Luftfilter Felt air filter insert for D1105 engine	25000019
Filtersatz für Motor D1105 ab ca. Bj 1996 Filter set for motor D1105 from approx. construction year 1996	 bestehend aus: Kraftstoff Filter, Hydraulik Ölfilter Einsatz, Motoröl Filter, Luftfilter Einsatz. Ohne Luftfilter Sicherheitspatrone Includes: fuel filter, hydraulic oil filter insert, engine oil filter, air filter insert	41500452
Edelstahl Auspuff Stainless steel exhaust	 Auspuffrohre Partikelfilter für VM-203 Exhaust pipe particle filter for VM-203	41500327
Luftfilterdeckel Air filter cover	 Deckel zu Luftfiltergehäuse D1105 Cover for air filter housing D1105	25000032

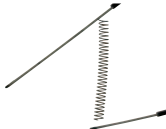

Verlegemaschinen / Installation Machines VM-203/204/301

Artikel / Article	Beschreibung / Description	Best.-Nr. / Order-Number
Ventildeckeldichtung Valve cover seal	 Ventildeckeldichtung D950 Valve cover seal D950	21590002
Ventildeckeldichtung Valve cover seal	 Ventildeckeldichtung D1105 Valve cover seal D1105	21590026
Dichtring Seal ring	 Dichtring für Ventildeckelschrauben (Bedarf: 3 Stück) Seal ring valve cover screw (3 pc. required)	26150008
Filterpatrone Filter cartridge	 für Dieselpartikelfilter DPF for diesel particle filter DPF	26900034
Schalldämpfer Silencer	 Schalldämpfer verstärkt zu D1105. Komplett mit Gewindebolzen und Dichtungen Silencer reinforced to D1105. Complete with threaded bolts and seals	41500818
Handbremsseilzug Handbrake cable	 Wie Art-Nr. 26090005, aber mit Bremse an beiden Räder für VM-203 und VM-301 As Order-Number 26090005 but with break on both wheels for VM-203 and VM-301	26090002
Handbremsseilzug Handbrake cable	 Wie oben, aber für VM-204 mit Bremse an beiden Räder As above but for VM-204 with break on both wheels	26090004
Keilriemen V-belt	 10 x 900. LA=900, Lw=884 für D950 10 x 900. LA=900, Lw=884 for D950	21100001
Keilriemen V-belt	 Keilriemen für D1105 für VM-203 / VM-301 V-belt for D1105 for VM-203 / VM-301	21100077
Keilriemen V-belt	 Keilriemen für VM-204 V-belt for VM-204	21100005
Kraftstofftank Fuel tank	 Tank für VM-203/301, vormontiert komplett Tank for VM-203/301, pre-assembled complete	41500795







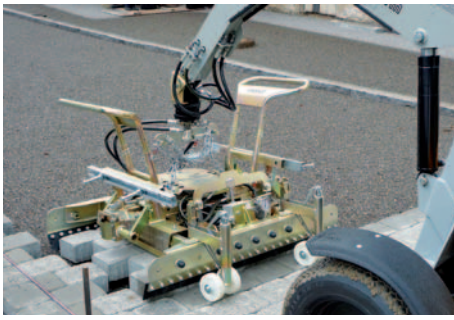

Verlegemaschinen / Installation Machines VM-203/204/301

Artikel / Article	Beschreibung / Description	Best.-Nr. / Order-Number
Schaltelement Joystick Joystick switching element	 Kontaktelement blau für Joystick VM-204 Contact element blue for joystick VM-204	24110070
Drucktaster Push button	 Drucktaster Joystick für Drehen/Hupen/Automatik VM-204 Push button Joystick for turning / beeping / automatic mechanism VM-204	24110100
Drucktaster Push button	 Drucktaster Joystick rot für VM-301 Push button Joystick red for VM-301	24110099
Drucktaster Push button	 Drucktaster Joystick blau für VM-301 Push button Joystick blue for VM-301	24110157
Scheibenwischerblatt Wiper blade	 Wischerblatt für VM-204/VM-301 Wiper blade for VM-204/VM-301	26810006
Druckknopf Hupe VM-301 Push button horn VM-301	 Druckknopf Hupe Push button horn	41500033

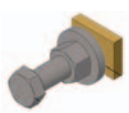

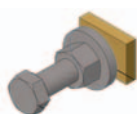
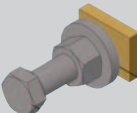
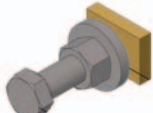
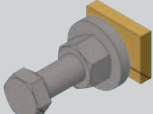
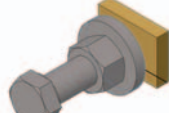
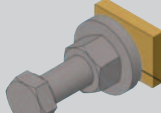



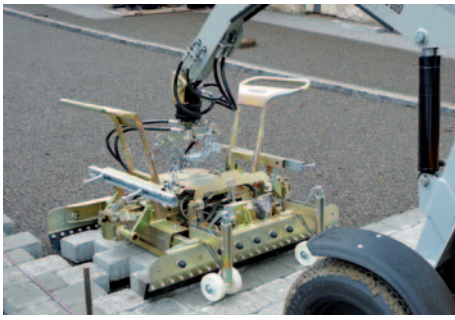



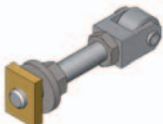
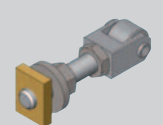

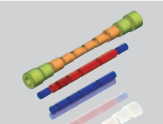
Allgemeine Ersatzteile für Hydraulische Verlegezangen HVZ Basic Spare Parts for Hydraulic Installation Clamps HVZ

Artikel / Article	Beschreibung / Description	Best.-Nr. / Order-Number
HD-Schlauch HD hose 	HD-Verbindungsschlauch 1.700 mm HD 1,700 mm connecting hose	22000007
HD-Schlauch HD hose 	HD-Verbindungsschlauch 2.500 mm HD 2,500 mm connecting hose	22000014
HVZ-Positionsadapter HVZ position adapter 	HVZ-Positionsadapter 80 mm mit Nutstein und Schrauben 80 mm HVZ position adapter with tenon block and screws	41400123
HVZ-Positionsadapter HVZ position adapter 	HVZ-Positionsadapter 100 mm mit Nutstein und Schrauben 100 mm HVZ position adapter with tenon block and screws	41400036
HVZ-Positionsadapter HVZ position adapter 	HVZ-Positionsadapter 110 mm mit Nutstein und Schrauben 110 mm HVZ position adapter with tenon block and screws	41400121
HVZ-Positionsadapter HVZ position adapter 	HVZ-Positionsadapter 120 mm mit Nutstein und Schrauben 120 mm HVZ position adapter with tenon block and screws	41400128
HVZ-Positionsadapter HVZ position adapter 	HVZ-Positionsadapter 130 mm mit Nutstein und Schrauben 130 mm HVZ position adapter with tenon block and screws	41400129
HVZ-Positionsadapter HVZ position adapter 	HVZ-Positionsadapter 140 mm mit Nutstein und Schrauben 140 mm HVZ position adapter with tenon block and screws	41400130
HVZ-Positionsadapter HVZ position adapter 	HVZ-Positionsadapter 150 mm mit Nutstein und Schrauben 150 mm HVZ position adapter with tenon block and screws	41400131
HVZ-Positionsadapter HVZ position adapter 	HVZ-Positionsadapter 160 mm mit Nutstein und Schrauben 160 mm HVZ position adapter with tenon block and screws	41400132
Gewindeplatte Positionsadapter Threaded plate Position adapter 	Gewindeplatte für Positionsadapter Threaded plate for position adapter	20190004



Allgemeine Ersatzteile für Hydraulische Verlegezangen HVZ Basic Spare Parts for Hydraulic Installation Clamps HVZ

Artikel / Article	Beschreibung / Description	Best.-Nr. / Order-Number
HVZ Positionsadapter Rolle HVZ Position adapter roller		41401020
HVZ Positionsadapter Rolle HVZ Position adapter roller		41401010
HVZ Positionsadapter Rolle HVZ Position adapter roller		41401019
Adaptersatz UBA UBA adapter set		41400683
Halfeneisen Halfen anchoring system		34010065
Halfeneisen Halfen anchoring system		34010046
Halfeneisen Halfen anchoring system		34010018
Gewindeplatte Halfeneisen Threaded plate Halfen anchoring system		20190003
Dichtsatz Seal set		21510041
Lamelle Standard Rib standard		34010097
Lamelle standard Rib standard		34010099

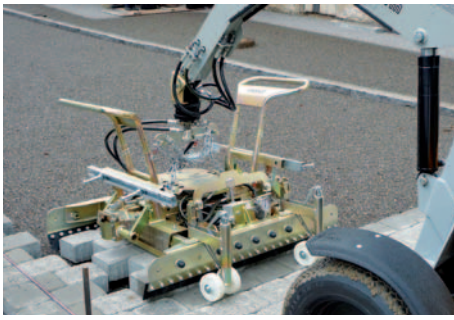

Allgemeine Ersatzteile für Hydraulische Verlegezangen HVZ Basic Spare Parts for Hydraulic Installation Clamps HVZ

Artikel / Article	Beschreibung / Description	Best.-Nr. / Order-Number
Lamelle standard Rib standard	 Lamelle breit, 5x150x95 geschlitzt Rib wide, 5x150x95 slotted	34010100
Lamelle lang Rib long	 Lamelle 5x120x100 geschlitzt Rib 5x120x100 slotted	34010059
Lamelle lang Rib long	 Lamelle lang, halbe Breite, 5x120x100/50 Rib long, half-width, 5x120x100/50	34010060
Lamelle lang Rib long	 Lamelle lang, breit 5x120x100/150 Rib long, wide 5x120x100/150	34010061
Tellerfedern Plate springs	 Tellerfedernsatz bestehend aus 144 Stück Plate spring set comprising 144 units	41400013
Sechskantmutter zu Tellerfedern Hex nut for plate springs	 Sechskantmutter M 12 (48 Stück Bedarf) Hex nut M 12 (48 units required)	20100017
Sechskantschraube zu Tellerfedern Hex screw for plate springs	 Sechskantschraube M 12 x 35 Hex screw M 12 x 35	20000025
Absetzrolle Set-down roller	 Polyamidrad 125/40 Polyamide wheel 125/40	21800001
Manometer	 HVZ-Manometer 400 bar (nicht für HVZ-uni-II) HVZ-Manometer 400 bar (not for HVZ-uni-II)	22130002
Bordwerkzeug On-board tools	 Rohrsteckschlüssel SW24 Tubular wrench SW24	70690041
Bordwerkzeug On-board tools	 Imbusschlüssel SW8 Allen key SW8	70630001

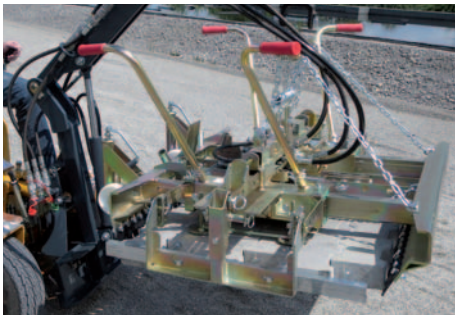



Hydraulische Verlegezange / Hydraulic Installation Clamp HVZ-STANDARD

Artikel / Article	Beschreibung / Description	Best.-Nr. / Order-Number
Zylinder Cylinder	 Zylinder Seitenspannung Cylinder side gripping	22200001
Zylinder Cylinder	 Zylinder Hauptspannung Cylinder main gripping	32200021
Bolzen Bolt	 Seitenspannung 20 x 79 Side gripping 20 x 79	30320037
Bolzen Bolt	 Seitenspannung 16 x 53 Side gripping 16 x 53	30320002
Bolzen Bolt	 Seitenspannung 20 x 71 Side gripping 20 x 71	30350009
Bolzen Bolt	 Klappspinn Linchpin	20540036
Gleitschiene Sliding rail	 Gleitführung Polyamid Polyamide sliding guide	36410026
Aufhängung Suspension	 Zugfeder 9x35x226x19 Tension spring 9x35x226x19	21710004
Aufhängung Suspension	 Kette 10 Glieder Chain 10 links	21000164
Aufhängung Suspension	 Kette 12 Glieder Chain 12 links	21000088
Aufhängung Suspension	 Schraube M10 x 45 10.9 Screw M10 x 45 10.9	20000239

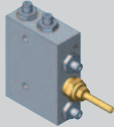
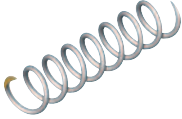

Hydraulische Verlegezange / Hydraulic Installation Clamp HVZ-STANDARD

Artikel / Article	Beschreibung / Description	Best.-Nr. / Order-Number
Aufhängung Suspension 	Schraube M10 x 65 10.9 Screw M10 x 65 10.9	20000261
Ventilblock Valve block 	Ventilblock inkl. Druckhalteventil Valve block incl. pressure retention valve	22040015
ADV 	Druckfeder ADV Compression spring ADV	21700009
ADV 	Führung ADV Guide ADV	41400489

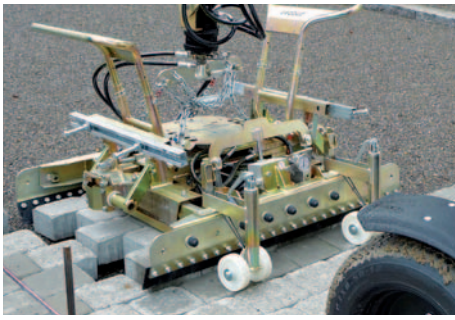

Hydraulische Verlegezange / Hydraulic Installation Clamp HVZ-UNI

Artikel / Article	Beschreibung / Description	Best.-Nr. / Order-Number
Gleitführung Sliding guide	 PE-Gleitführung unten PE sliding guide bottom	36400207
Gleitführung Sliding guide	 PE-Gleitführung oben PE sliding guide top	36400208
Handgriff Handle	 Handgriff oben komplett Top handle complete	41400252
ADV	 Führung ADV guide	41400489
ADV	 Rückschlagventil für ADV-Zylinder im ADV-Block Check valve for ADV cylinder in ADV block	22040030
ADV	 Federriegel ADV Schiene Spring lock ADV bar	20540024
ADV	 Einstellbare Abdrückschiene komplett Adjustable pressure rail complete	41400245
ADV	 Druckfeder ADV compression spring	21700030
ADV	 Kolbenstange mit Führung und Dichtung Piston rod with guide and seal	21540005
ADV	 Dichtungssatz für ADV-Zylinder Seal set for ADV cylinder	21540004
Gummi Absetzrolle Rubber Set-down roller	 O-Ring, 100 x 6 zu Absetzrolle O-ring, 100 x 6 for set-down roller	21550058

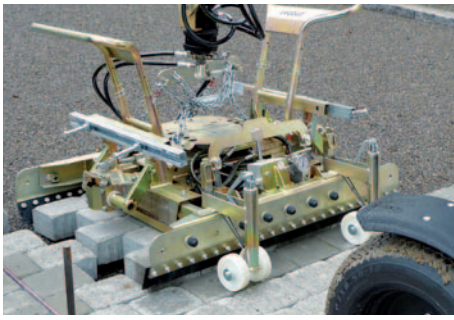

Hydraulische Verlegezange / Hydraulic Installation Clamp HVZ-UNI

Artikel / Article	Beschreibung / Description	Best.-Nr. / Order-Number
Absetzrolle Set-down roller 	Absetzrolle komplett Set-down roller complete	41400313
ADV Ventil ADV valve 	Druckfolgeventil kurz Pressure sequence valve, short	22030032
ADV Ventil ADV valve 	Druckfolgeventil lang Pressure sequence valve, long	22030033
Kette an Wangen Chain on cheeks 	Kette DIN 5685 23 Glieder (Bedarf 2 Stück) DIN 5685 chain 23 links (requirement: 2 units)	21000179
Kette an Aufhängung Chain on suspension 	Kette DIN 5685 38 Glieder (Bedarf 2 Stück) DIN 5685 chain 38 links (requirement: 2 units)	21000180
Höhenverstellung Height adjustment 	Höhenverstellung komplett links Height adjustment complete left	41400258
Höhenverstellung Height adjustment 	Höhenverstellung komplett rechts Height adjustment complete right	41400259
Schäkel Aufhängung Shackle suspension 	Schäkel hochfest 0,75 t Shackle high-tensile 0.75 t	21030006
Spannhülse Clamping sleeve 	für Schäkel hochfest 0,75 t an HVZ-Mittelteil for shackle high-strength 0.75 t on HVZ middle port	20530069
Schäkel Kette Wange Shackle chain cheek 	Schäkel verzinkt 0,25 t Shackle galvanized 0.25 t	21030002
Seitenspannung Side gripping 	Schweißteil an Zahnstange Bolt short	41400314

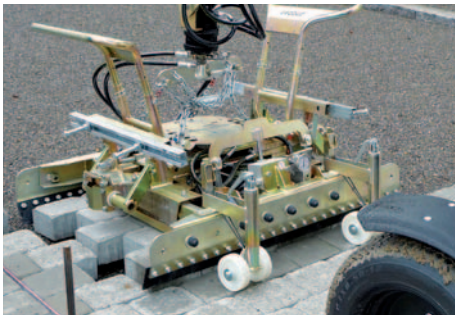





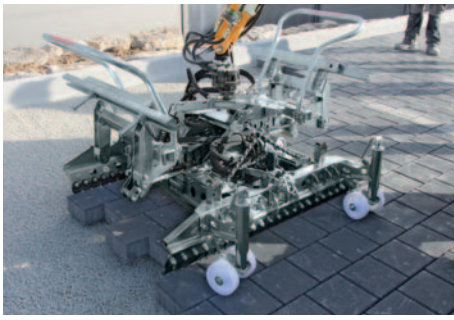



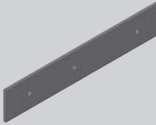

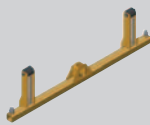
Hydraulische Verlegezange / Hydraulic Installation Clamp HVZ-UNI

Artikel / Article	Beschreibung / Description	Best.-Nr. / Order-Number
Seitenspannung Side gripping	 Bolzen kurz Bolt short	33310006
Seitenspannung Side gripping	 Bolzen lang Bolt long	33310003
Hauptspannung Main gripping	 Zylinder komplett für Hauptspannung Cylinder complete for main gripping	32200021
Seitenspannung Side gripping	 Zylinder komplett für Nebenspannung Cylinder complete for side gripping	22210046
Ventilblock Valve block	 Ventilblock inkl. Druckhalteventil Valve block incl. pressure retaining valve	22040015
Schutzkappe Protective cap	 Schutzkappe Schraubenkopf an Lamellenträger Protective cap screw head on support strap	21070065
Druckschalter Pressure switch	 Druckschalter mit Würfelstecker Pressure switch	24110020
Karabiner Snap hook	 Karabinerhaken 60 x 6 Snap hook 60 x 6	21020012

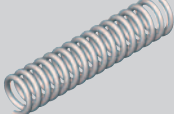

Hydraulische Verlegezange / Hydraulic Installation Clamp HVZ-UNI-II

Artikel / Article	Beschreibung / Description	Best.-Nr. / Order-Number
Gleitführung Sliding guide	 PE-Gleitführung unten PE sliding guide bottom	36400390
Gleitführung Sliding guide	 PE-Gleitführung oben PE sliding guide top	36400391
Handgriff Handle	 Handgriff oben komplett Handle top complete	41401102
ADV	 Einstellbare Abdrückschiene komplett ohne Verbreiterung Adjustable pressure rail complete with no expansion	41400975
Verbreiterung Expansion	 Verbreiterung für Abdrückschiene Expansion for pressure rail	41400240
ADV	 Gummianschlag ADV, 10 mm breit ADV rubber stop, 10 mm wide	21070138
ADV	 Hydraulikzylinder ADV hydraulic cylinder	22210041
ADV	 Druckfeder ADV pressure spring	21700091
Absetzrolle Set-down roller	 Absetzrolle komplett Set-down roller complete	41400962
Absetzrolle Set-down roller	 Feder für Absetzrolle Spring for set-down roller	21710011
Kette an Aufhängung Chain on suspension	 Kette mit Schutzschlauch für Aufhängung Chain with protective hose for suspension	41400945

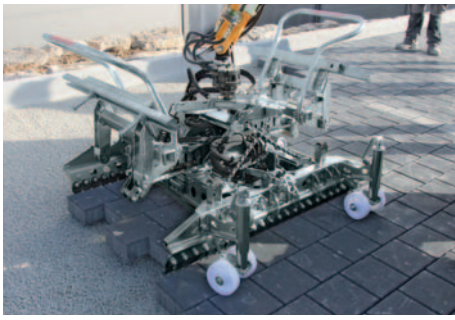

Hydraulische Verlegezange / Hydraulic Installation Clamp HVZ-UNI-II

Artikel / Article	Beschreibung / Description	Best.-Nr. / Order-Number
Feder Aufhängung Spring suspension	 Feder an Aufhängung Spring on suspension	21710026
Höhenverstellung Height adjustment	 Höhenverstellung links komplett Height adjustment left complete	41400969
Höhenverstellung Height adjustment	 Höhenverstellung rechts komplett Height adjustment right complete	41400970
Seitenspannung Side gripping	 Anschlag Gummipuffer zylindrisch Stop rubber buffer cylindrical	21070009
Seitenspannung Side gripping	 Zylinder komplett für Seitenspannung Cylinder complete for side gripping	22200090
Seitenspannung Side gripping	 Dichtsatz für Seitenspannung Seal set for side tensioning	21510055
Hauptspannung Main gripping	 Zylinder komplett für Hauptspannung Cylinder complete for main gripping	32200021
Handgriff Handle	 Handgriff Wange rot Cheek handle red	21600016
Auflage Support	 Polyamidauflage für Aufhängung Polyamide support for suspension	36400377
Manometer	 Manometer 400 bar	22130030

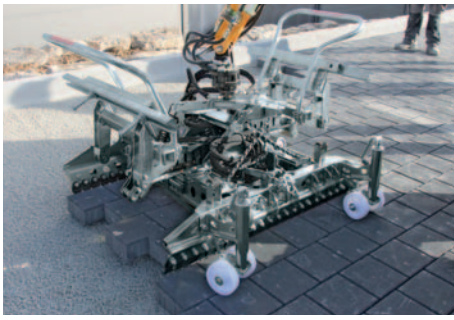



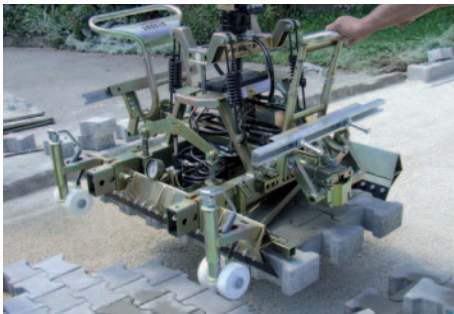

Hydraulische Verlegezange / Hydraulic Installation Clamp HVZ-UNI-II

Artikel / Article	Beschreibung / Description	Best.-Nr. / Order-Number
Hülse Federaufhängung Spacer spring suspension 	Distanzhülse Federaufhängung unten Spacer spring suspension below	33100184
Hülse Federaufhängung Spacer spring suspension 	Distanzhülse Federaufhängung oben Spacer spring suspension on top	33100183



Hydraulische Verlegezange / Hydraulic Installation Clamp HVZ-GENIUS-BASIC

Artikel / Article	Beschreibung / Description	Best.-Nr. / Order-Number
ADV 	Führung für ADV Guide for ADV	41400489
Höhenverstellung Height adjustment 	Höhenverstellung komplett links Height adjustment complete left	41400258
Höhenverstellung Height adjustment 	Höhenverstellung komplett rechts Height adjustment complete right	41400259
Gleitführung Sliding guide 	PE-Gleitführung oben PE sliding guide top	36410124
Gleitführung Sliding guide 	PE-Gleitführung unten PE sliding guide bottom	36410123











Hydraulische Verlegezange / Hydraulic Installation Clamp HVZ-GENIUS

Artikel / Article	Beschreibung / Description	Best.-Nr. / Order-Number
ADV 	Führung für ADV Guide for ADV	41400489
Handgriff Handle 	Handgriff Oberteil Handle Top	33120017
ADV 	ADV Schiene Verbreiterung ADV rail expansion	41400240
ADV 	ADV Druckfeder pressure spring	21700030
ADV 	Kolbenstange mit Führung und Dichtung Piston rod with guide and seal	21540005
ADV 	Dichtungssatz für ADV-Zylinder Seal set for ADV cylinder	21540004
Gummi Absetzrolle Rubber Set-down roller 	O-Ring zu Absetzrolle O-ring on Set-down roller	21550058
Absetzrolle Set-down roller 	Absetzrolle komplett Set-down roller complete	41400646
Hydraulikventil Hydraulic valve 	Stromregelventil für Trommelgeschwindigkeit (vorwärts/rückwärts) Flow regulating valve for bowl speed (forwards/backwards)	22230023
Feder Aufhängung Spring suspension 	Feder für Aufhängung Spring for suspension	21710010
Höhenverstellung Height adjustment 	Höhenverstellung links Height adjustment left	41400258

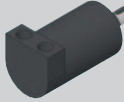

Hydraulische Verlegezange / Hydraulic Installation Clamp HVZ-GENIUS

Artikel / Article	Beschreibung / Description	Best.-Nr. / Order-Number
Höhenverstellung Height adjustment	 Höhenverstellung rechts Height adjustment right	41400259
Seitenspannung Side gripping	 Zylinder komplett für Seitenspannung Cylinder complete for side gripping	22200089
Seitenspannung Side gripping	 Dichtsatz für Seitenspannung Seal set for side tensioning	21510055
Hauptspannung Main gripping	 Zylinder komplett für Hauptspannung Cylinder complete for main gripping	32200021
Auflage Support	 Polyamidauflage für Aufhängung Polyamide support for suspension	36400276
Verbreiterung Wange Cheek expansion	 Verbreiterung hinten (Maschinenseite) kpl. Expansion back (machine side) complete	41400870
Verbreiterung Wange Cheek expansion	 Verbreiterung vorne (Planumseite) kpl. Expansion front (planum side) complete	41400871
Trommelsteuerung Bowl control	 Antriebsmotor für Trommelsteuerung Drive motor for bowl control	22400004
Trommelsteuerung Bowl control	 Trommelsteuerung vormontiert, komplett ohne Nocken Bowl control preinstalled, complete with no cam	41400507
Dichtring Seal ring	 Dichtring für Trommelsteuerung Seal ring for drum gear	21570044

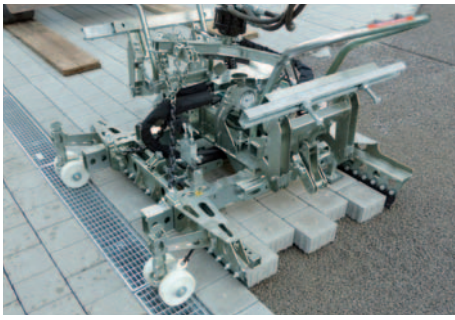

Hydraulische Verlegezange / Hydraulic Installation Clamp HVZ-ECO

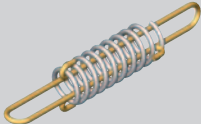
Artikel / Article	Beschreibung / Description	Best.-Nr. / Order-Number
Gleitführung Sliding guide	 Gleitführung maschinenseitig Sliding guide machine side	36400340
Gleitführung Sliding guide	 Gleitführung planumseitig Sliding guide planum side	36400339
ADV	 ADV Schiene komplett ohne Verbreiterung ADV rail complete without expansion	41400937
Verbreiterung Expansion	 Verbreiterung für Abdrückschiene Expansion for pressure rail	41400632
ADV	 ADV Druckfeder ADV pressure spring	21700069
ADV	 ADV Gummianschlag 10 mm ADV rubber stop 10 mm	21070138
ADV	 ADV Hydraulikzylinder ADV hydraulic cylinder	22210041
Absetzrolle Set-down roller	 Absetzrolle komplett Set-down roller complete	41400962
Gummi-Absetzrolle Rubber set-down roller	 O-Ring zu Absetzrolle O-ring for set-down roller	21550048
Feder Aufhängung Spring suspension	 Feder für Aufhängung Spring for suspension	21710010
Kette an Aufhängung Chain on suspension	 Kette mit Schutzschlauch an Aufhängung Chain with protective hose on suspension	41400945

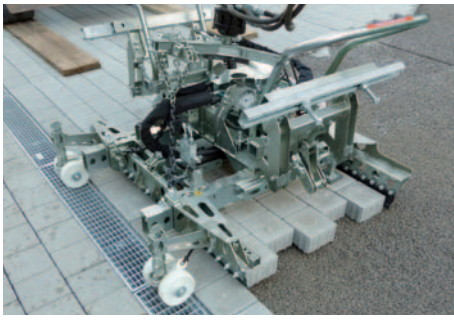

Hydraulische Verlegezange / Hydraulic Installation Clamp HVZ-ECO

Artikel / Article	Beschreibung / Description	Best.-Nr. / Order-Number
Höhenverstellung Height adjustment	 Höhenverstellung komplett links Height adjustment complete left	41400969
Höhenverstellung Height adjustment	 Höhenverstellung komplett rechts Height adjustment complete right	41400970
Seitenspannung Side gripping	 Anschlag Gummipuffer zylindrisch Rubber buffer stop cylindrical	21070009
Seitenspannung Side gripping	 Zylinder für Seitenspannung Cylinder for side gripping	22200090
Seitenspannung Side gripping	 Dichtsatz für Seitenspannung Seal set for side tensioning	21510055
Hauptspannung Main gripping	 Zylinder für Hauptspannung Cylinder for main gripping	32200021
Auflage Support	 Polyamidauflage für Aufhängung (bei Art.-Nr. 51400031) Polyamide support for suspension (for art. no. 51400031)	36400349
Auflage Support	 Polyamidauflage für Aufhängung (bei Art.-Nr. 51400034) Polyamide support for suspension (for art. no. 51400034)	36400377
Trommelsteuerung Bowl control	 Antriebsmotor für Trommelsteuerung Drive motor for bowl control	22400004
Trommelsteuerung Bowl control	 Trommelsteuerung komplett vormontiert ohne Nocken Bowl control complete preinstalled with no cam	41400507
Handgriff Handle	 Handgriff Wange vorn Cheek handle front	21600016

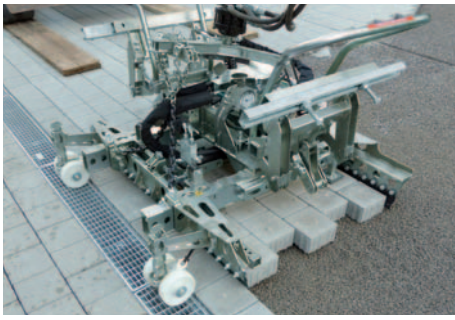

Hydraulische Verlegezange / Hydraulic Installation Clamp HVZ-ECO

Artikel / Article	Beschreibung / Description	Best.-Nr. / Order-Number
Schäkel Aufhängung Shackle suspension	 Schäkel Kettenaufhängung Shackle chain suspension	21030019
Dichtring Seal ring	 Dichtring für Trommelsteuerung Seal ring for drum gear	21570044



Verbundstein Transportkarre / Adjustable Paver Transport Cart VTK-V

Artikel / Article	Beschreibung / Description	Best.-Nr. / Order-Number
VTK-Backen VTK jaws	 Backen zu VTK-V Jaws for VTK-V	41100069
VTK-Betätigungshebel VTK operating lever	 Betätigungshebel mit Lagerung zu VTK-V Operating lever with bearing to VTK-V	41100084
VTK-Rad komplett VTK wheel complete	 Lufrad 4.00 - 4.V76 für SH und VTK-V Decke Fabrikat KENDA 4.00 - 4.V76 air wheel for SH and VTK-V casing made by KENDA	21850005
VTK-Rad VTK wheel	 Decke (Gummireifen) zu Reifen Cover (rubber tyres) for tyres	21850006
VTK-Rad VTK wheel	 Schlauch zu Reifen Tube for tyres	21850007







Verbundstein Transportkarre / Adjustable Paver Transport Cart VTK-V

Artikel / Article	Beschreibung / Description	Best.-Nr. / Order-Number
VTK-Schwenkhebel VTK swing lever 	Schwenkhebel mit Backenaufnahme zu VTK-V Swing lever with jaw holder to VTK-V	41100085
VTK-Stützrad VTK support wheel 	Stützrad für VTK-V Support wheel for VTK-V	41100041
VTK-Überlastsicherung VTK overload protection 	Überlastsicherung zu VTK-V Overload protection for VTK-V	41100080
Bolzen mit Scheibe Bolt with washer 	Dm 20, Lochabstand 37, Länge 45, Breite 5 Dm 20, hole spacing 37, length 45, width 5	30300054
Klappsplint Clip pin 	4,5 mm, verzinkt. Schaftlänge 40/Ring-Dm 40 4.5 mm, galvanized. Shaft length 40/Ring-Dm 40	20540001
Handgriff Handle 	Handgriff für VTK-V Handle for VTK-V	41100067
Handgriff Handle 	Handgriff Gummi rot Handle rubber red	21600016



Palettenwagen / Pallet-Cart PW-III





(Alt, Art.-Nr. 51100009)
(Old, Order-Nr. 51100009)

Artikel / Article	Beschreibung / Description	Best.-Nr. / Order-Number
Rad Wheel	 Rad klein, komplett mit Felge und Hülse Small wheel, complete with rim and sleeve	21850021
Rad Wheel	 Rad groß, komplett mit Flansch/Lager Large wheel, complete with flange/bearing	21850020
Rad Wheel	 Nabe für Rad, groß Hub for wheel, large	42310007
Dichtsatz Seal kit	 Dichtsatz für HD-Zylinder Seal kit for HD cylinder	21510053
HD-Zylinder HD-Cylinder	 HD-Zylinder komplett mit Hebel HD cylinder complete with lever	26800003



Palettenwagen / Pallet-Cart PW-III

(Neu, Art.-Nr. 51100011)
(New, Order-Nr. 51100011)

Artikel / Article	Beschreibung / Description	Best.-Nr. / Order-Number
Rad Wheel	 Rad klein, komplett Wheel small, complete	21850021
Rad Wheel	 Rad groß Wheel large	21850039
Rad Wheel	 Nabe für Rad, groß Hub for wheel, large	21870004
Deichsel Draw bar	 Deichsel komplett Draw bar complete	42300038
HD-Zylinder HD-Cylinder	 HD-Zylinder komplett mit Hebel HD cylinder complete with lever	26800007





Pflasterverfugungsgerät / Paver Jointing Device EASYFILL EF-H / EF-H-GREENLINE

Artikel / Article	Beschreibung / Description	Best.-Nr. / Order-Number
Bürste Brush	 Bürste mit Poly 1.5 300 mm lang Brush with poly 1.5, 300 mm long	41700002
Rad Wheel	 Vollgummirad 125-37 125-37 solid rubber wheel	21820008
Stehlager Pedestal bearing	 Stehlager Gehäuseeinheit Durchmesser 20 Pedestal bearing housing unit diameter 20	21380002
Keilriemen V-belt	 Keilriemen XPZ-1287 (10 x 8) XPZ-1287 (10 x 8) V-belt	21100009
Kettenrad Chain wheel	 Kettenrad einbaufertig gebohrt 114 z. groß Chain wheel ready to install, drilled 114 z. large	21200025
Kettenrad Chain wheel	 Kettenrad mit Bund für Rollenkette, 15 z. Chain wheel with collar for roller chain	21200006
Kugellager Ball bearings	 Kugellager für Bürstenaufnahme (Bedarf: 2 verschiedene Kugellager + Abschlußkappe) Ball bearings for brush mounting (requirement: 2 different ball bearings + sealing cap)	21340002 21100045 21070145
Rollenkette Roller chain	 Einfach-Rollenkette Länge 1276 mm mit Kettenschloss Simple roller chain length 1276 mm	21000188
Bowdenzug EF-H Bowden cable EF-H	 Bowdenzug mit Bedienteil nur für Benzin Version Bowden cable with operating panel only for patrol version	21600026
KFE Kugelhahn KFE ball valve	 KFE Kugelhahn mit Flügelgriff KFE ball valve with wing handle	27110002
Federriegel Spring lock	 Federriegel mit M 18 x 1 Mutter Spring lock with M 18 x 1 nut	20540024

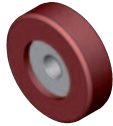
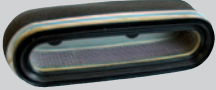
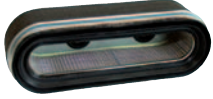

Pflasterverfugungsgerät / Paver Jointing Device EASYFILL EF-H / EF-H-GREENLINE

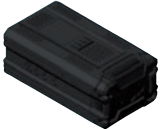
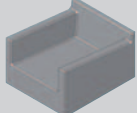
Artikel / Article	Beschreibung / Description	Best.-Nr. / Order-Number
Laufrolle Castor 	Laufrolle aus PU PU castor	21840002
Luftfilter EF-H Airfilter EF-H 	Luftfilter Einsatz, L = 180 mm (Motorgehäuse schwarz) nur Benzin Variante Air filter insert, L = 180 mm (Motor housing black) only patrol version	25000041
Luftfilter EF-H Airfilter EF-H 	Luftfilter-Einsatz (Motorgehäuse rot) nur Benzin Variante Air filter insert (Motor housing red) only patrol version	25000038
Zündkerze EF-H Spark plug EF-H 	Zündkerze für Honda GXV 160 nur Benzin Variante Spark plug for Honda GXV 160 only patrol version	26910007
Akku EF-H-GREENLINE 	Akku	24200148
Ladegerät EF-H-GREENLINE Charger EF-H-GREENLINE 	Ladegerät Charger	24110216



Pflasterreinigungsgerät / Paver Cleaning Device EASYCLEAN EC-60

Artikel / Article	Beschreibung / Description	Best.-Nr. / Order-Number
Zündkerze Spark plug	 Zündkerze Spark plug	26910009
Luftfilter Airfilter	 Luftfilter Airfilter	26110034
Oberteil Top section	 Oberteil für Rotorgehäuse inkl. Verdrehsicherung Edelstahl Top section for rotor housing, incl. anti-twist device stainless steel	21450015
Unterteil Bottom section	 Unterteil der Durchführung Rotor komplett m. Düsen Bottom section of the rotor duct complete with nozzles	41700029
Kugellager Ball bearing	Kugellager für Drehdurchführung (Bedarf 2 St.) Ball bearing for rotary transmission (req. 2 pc.)	21350018
Drehdurchführung Seal rotary transmission	 Bei vorhandenem Oberteil aus V2A Edelstahl For existing top in V2A stainless steel	28000041
Abdichtung Drehdurchführung Seal rotary transmission	 Bei vorhandenem Oberteil aus Messing (alt) For existing top in brass (old)	28000029
Düse Nozzle	 Düse 1/4 1/4 nozzle	27190001
Satz Mink-Bürsten Set of mink brushes	 Mink-Bürsten für EC-60 Mink brushes for EC-60	27230010
Ersatz Spritzlappen Replacement splash flaps	 Spritzlappen für EC-60 Splash flaps for EC-60	36600012
PVC-Saug-und Druckschlauch PVC hose and pressure hose	 PVC Schlauch mit Gewebeeinlage farblos 960 lang PVC hose with fabric lining colourless 960 long	23000027







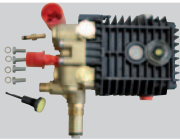

Pflasterreinigungsgerät / Paver Cleaning Device EASYCLEAN EC-60

Artikel / Article	Beschreibung / Description	Best.-Nr. / Order-Number
Verbindungsschlauch Connecting hose 	Verbindungsschlauch von Pumpe zu Drehdurchführung Connecting hose from pump to rotary joint	28000022
PVC-Schlauch PVC hose 	PVC Schlauch mit Gewebeeinlage, 450 mm PVC hose with fabric lining, 450 mm	23000020
Rad Wheel 	Rad abgedichtet 100 x 34 Wheel sealed 100 x 34	21820014
Wasserkupplung-Muffe Water coupling sleeve 	Wasserkupplung-Muffe 280 bar 3/8 Water coupling sleeve 280 bar 3/8	28000023
Wasserkupplung-Stecker Water coupling plug 	Wasserkupplung-Stecker, 175 bar, 3/8 Water coupling plug, 175 bar, 3/8	28000024
Wasserschlauchadapter Water hose adapter 	Wasserschlauchadapter WSA-Gardena von Bayonett auf Gardena WSA Gardena water hose adapter from bayonet to Gardena	28000018
Federriegel Spring lock 	Federriegel mit M18 x 1 Mutter Spring lock with M18 x 1 nut	20540024
KFE Kugelhahn KFE ball valve 	KFE Kugelhahn mit Flügelgriff 1/2 - 3/4 an Handgriff KFE ball valve with 1/2 - 3/4 wing handle	27110002
Durchflussbegrenzung Flow restriction 	Durchflussbegrenzer der Querspülung Flow limiter for cross flushing	33505453
Passfeder Feather key 	Feder zwischen Motor und Pumpe Spring between motor and pump	21750018
Druckschalter Pressure switch 	Membrandruck-Schalter, 0,3 bar Membrane pressure switch, 0.3 bar	22900008



Pflasterreinigungsgerät / Paver Cleaning Device EASYCLEAN EC-60

Artikel / Article	Beschreibung / Description	Best.-Nr. / Order-Number
Handgriff Handle	 Softgriff für Lenker (Paar) Soft grip for handlebars (pair)	21600034
Hochdruckpumpe High-pressure pump	 Hochdruckpumpe (Interpump) High-pressure pump (Interpump)	26110022
Verschleisteile SET (Interpump) SET wearing parts	bestehend aus Ein- und Auslassventil, Öldichtungssatz, Kolbendichtungssatz und O-Ring 20 x 3 mm Dm Comprising inlet and outlet valve, oil seal set, piston seal set and 20 x 3 mm Dm O-ring	41700033
Hochdruckpumpe High-pressure pump	 Hochdruckpumpe mit Zumischer (Comet), ab ca. Bj. 2006 High-pressure pump with add-mixer	26110038
ET für Comet Pumpe ET for Comet Pumpe	 Kit A: Ventilsatz komplett (6 Stück) Kit A: Valve set complete (6 units)	28000032
ET für Comet Pumpe ET for Comet Pumpe	 Kit B: Kolbendichtungssatz Kit B: Piston seal set	28000033
ET für Comet Pumpe ET for Comet Pumpe	 Kit C: Kolbensatz Kit C: Piston set	28000034
ET für Comet Pumpe ET for Comet Pumpe	 Kit D: Dichtungssatz Pumpe Kit D: Pump seal set	28000035
Schmutzfänger Strainer	Schmutzfänger Siebeinsatz Strainer for sieve	27150035





Flächenfertiger / Screeding Machine POWERPLAN PP

Artikel / Article	Beschreibung / Description	Best.-Nr. / Order-Number
Wartungskit klein Service kit small 	bestehend aus: Motorölfilter, Kraftstoffvorfilter, Kraftstoff Filter Einsatz, Luftfilter includes: engine oil filter, fuel prefilter, fuel filter set, air filter	41300179
Wartungskit groß Service kit big 	Wartungskit klein + Luftfilter-Feinfilter, Sauganschluss für Kraftstofftank, Keilriemen Service kit small + Air-Fine-Filter, Suction Connection Fuel Tank, V-Belt	41300224
Keilriemen V-belt 	Keilriemen 10 x 950 V-belt 10 x 950	21100005
Drucktaster Bohle Pressure button for plank 	IP65, Drucktaster Bohlenbetätigung, runde Version IP65, Pressure button for plank operation, round version	24110072
Drucktaster Bohle Pressure button for plank 	Drucktaster Bohlenbetätigung Pressure button for plank operation	24110152
Gaszug Accelerator cable 	kpl. mit PVC-Rohr und Endkappen complete with PVC pipe and end cap	41300178
A-Rad (Standard) Z14/72 A-wheel (standard) Z14/72 	Innen-DM 204 mm, zu Gummiraupen- Fahrschiff, schwarz internal DM 204 mm, for rubber crawler track, black	21200017
A-Rad (Hardox) Z14/72 A-wheel (Hardox) Z14/72 	Innen-DM 204 mm, zu Gummiraupen- Fahrschiff, schwarz internal DM 204 mm, for rubber crawler track, black	21200016
Gummiraupenband Rubber crawler belt 	250 x 57 x 72 mm (Dongil) 250 x 57 x 72 mm (Dongil)	21200015
Laufrolle Roller 	für Linearführung for linear guide	41300051
Ventildeckeldichtung Valve cover seal 	Ventildeckeldichtung Kopfdeckel Valve cover seal Head cover	21590073



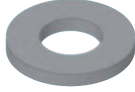
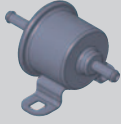

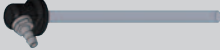

Flächenfertiger / Screeding Machine POWERPLAN PP

Artikel / Article	Beschreibung / Description	Best.-Nr. / Order-Number
Dichtring Seal ring 	Dichtring für Ventildeckelschrauben (Bedarf: 4 Stück) Seal ring for valve cover screw (4 pieces required)	26150008
Kraftstoffpumpe Fuel pump 	Kraftstoffpumpe Fuel pump	26120005
Filter 	Sicherheitspatrone Luftfilter Air filter safety cartridge	25000019
Sauganschluss Tank Tank suction connection 	Sauganschluss mit Filtersieb Suction connection with filter strainer	26200016

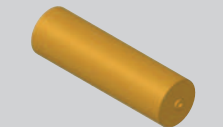

Teleskop Abziehkübel / Telescopic Screeding Bucket TAK

Artikel / Article	Beschreibung / Description	Best.-Nr. / Order-Number
TAK-Klemmverstellung TAK terminal adjustment	 Klemmverstellung mit 2 Ringmuttern für TAK-Profil, n. ZNr N187-452 Terminal adjustment with 2 ring nuts for TAK profile n. ZNr N187-452	41000080
Ringschraube Ring bolt	 Ringschraube M 10 x 80 verzinkt, Seitenteil lang M 10 x 80 ring bolt galvanized, Side part long	20080008
Ringmutter Ring nut	 Ringmutter M 10 Klemmverstellung M 10 ring nut terminal adjustment	41000101
Tragrollen Support rollers	 Tragrollen Typ 89/20 Support rollers of type 89/20	21810001
Zugkette Drive chain	 Kette ca. 5 m lang, 263 Glieder Chain approx. 5 m long, 263 links	41000260
Ringschraube Ring bolt	 Ringschraube Seitenteil, kurz Ring bolt side part, short	20080005







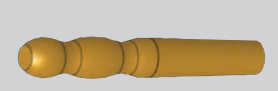

Teleskop Abziehsystem / Telescopic Screeding System TAS-UNI

Artikel / Article	Beschreibung / Description	Best.-Nr. / Order-Number
TAS-UNI-Rad TAS-UNI wheel	 Polyamid-Rad 125-40, Gleitlager 20 mm, Nabe 45 mm, Tragkraft 250 kg Polyamide wheel 125-40, 20 mm slide bearing, 45 mm hub, loading capacity 250 kg	21800001
TAS-UNI-Klemmverstellung TAS-UNI terminal adjustment	 TAS-UNI Klemmverstellung, Klemmschiene, inkl. 2 Ringmuttern TAS-UNI terminal adjustment, terminal rail, incl. 2 ring nuts	41000157
Klappe/Splittabweiser Flap / grit deflector	 Klappe/Splittabweiser rechts Flap / grit deflector right	41000378
Klappe/Splittabweiser Flap / grit deflector	 Klappe/Splittabweiser links Flap / grit deflector left	41000373
Klappe/Splittabweiser Flap / grit deflector	 Steckbolzen zu Klappe/Splittabweiser Pin bolt for flap / grit deflector	41000068
Mitnehmer-Mutter Tappet nut	 Mitnehmermutter M 12 M 12 tappet nut	41000253
Abstreifer Wiper	 Abstreifer Links Wiper left	33700668
Abstreifer Wiper	 Abstreifer Rechts Wiper right	33700667
Ringschraube Ring bolt	 Ringschraube M 10 x 50 mit Scheibe M 10 x 50 ring bolt with washer	20080011
Ringmutter Ring nut	 Ringmutter M 10 mit Scheibe M 10 ring nut with washer	20110006
Gewindeplatte Threaded plate	 Gewindeplatte M 10 Threaded plate M 10	20190010

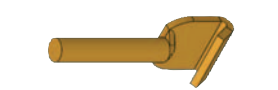

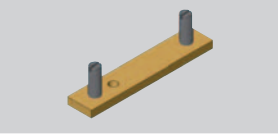



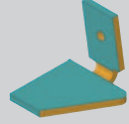

Handabziehsystem / Handscreeding System EASYPLAN EP-UNI

Artikel / Article	Beschreibung / Description	Best.-Nr. / Order-Number
Handgriff Handle	 Stiel kompl. mit Holzgriff ab 230 (4-fach Griff) Handle complete with wooden grip from 230 (4-way handle)	33750047
Handgriff Handle	 Holzgriff Wooden grip	21600017
Handgriff Handle	 Stiel kompl. mit Holzgriff (2-fach) bis 200 Handle complete with wooden grip (2-way) up to 200	33750048
Spannring Clamping ring	 Spannring Clamping ring	33750049
Spannhaken Tension hook	 für Spannverschluss an BE for tension lock on BE	21060011
Spannseil Tension cable	 Spannseil Tension cable	21000113
Nutstein Tenon block	 Nutstein Spannseil Ringschraube Tenon block Tension cable ring bolt	20190014
Nutstein Tenon block	 Nutstein komplett Profilverbreiterung Tenon block complete profile expansion	41000152
Ringschraube Ring bolt	 Ringschraube Spannseilbefestigung Ring bolt tension cable fixing	20080004







Handabziehsystem / Handscreeding System TELEPLAN TP

Artikel / Article	Beschreibung / Description	Best.-Nr. / Order-Number
Höhenauflage rechts Support height right	 Nutstein TP rechts TP tenon block right	41010028
Höhenauflage links Support height left	 Nutstein TP links TP tenon block left	41010027
Ringschraube Ring bolt	 Ringschraube Ring bolt	20080002
Vierkantmutter Square nut	 Vierkantmutter M 6 M 6 square nut	20150006
Befestigungs-Klemmset lin Fixing terminal set left	 Klammer links komplett Bracket left complete	41010054
Befestigungs-Klemmset rechts Fixing terminal set right	 Klammer rechts komplett Bracket right complete	41010055
Handgriff Handle	 PVC Handgriff 1/2" PVC handle 1/2"	21600005



Handplaniersystem / Manual Screeding System LEVELFIX LF

Artikel / Article	Beschreibung / Description	Best.-Nr. / Order-Number
Rad Wheel	 Rad mit Felge, gelb Wheel with rim, yellow	21820024
Rad Wheel	 Achskappe Axle cap	21870006
Rad Wheel	 Abschlusskappe für Radbefestigungshandgriff End cap for wheel fixing handle	21070142
Rad Wheel	 Radbefestigung Handgriff Wheel fixing handle	41000316
Rad Wheel	 Gewindeplatte Radbefestigung Threaded plate wheel fixing	20190003
Handgriff Handle	 PVC-Handgriff 3/4" PVC-handle 3/4"	21600016
Ringschraube Ring bolt	 Ringschraube M10 x 35 Ring bolt M10 x 35	20080019



Steinzieher / Paving Block Extractor SZ

Artikel / Article	Beschreibung / Description	Best.-Nr. / Order-Number
Messer kurz Blade short	 Ersatzmesser für Steinzieher SZ und Plattenzieher PZ und SAH Steinausheber, 55 mm Replacement blade for SZ block lifter and PZ tile lifter and SAH block excavator, 55 mm	41800001
Messer lang Blade long	 Ersatzmesser für Steinzieher SZ, längere Ausführung, 65 mm Replacement blade for SZ block lifter, longer design, 65 mm	41800003
Verschiebeeinheit Displacing unit	 Verschiebeeinheit für SZ (Schweissteil) Displacing unit for SZ (welded component)	41800015
Verschiebeeinheit Displacing unit	 Flügelschraube M 10 x 35 Wing screw M 10 x 35	20060021
Verschiebeeinheit Displacing unit	 Flügelmutter M 10 Wing nut M 10	20160011
Messerbefestigung Blade fixing	 Zylinderschraube M 8 x 25 Cylinder screw M 8 x 25	20020007
Messerbefestigung Blade fixing	 Sechskantmutter Hex nut	20100015
Handgriff Handle	 PVC-Handgriff 1/2" PVC-handle 1/2"	21600005
Rohrklappstecker Clip pin	 Rohrklappstecker Clip pin	20540050





Steinausheber / Paver Lifter SAH

Artikel / Article	Beschreibung / Description	Best.-Nr. / Order-Number
Messer kurz Blade short 	Ersatzmesser für Steinzieher SZ und Plattenzieher PZ und SAH Steinausheber Replacement blade for SZ block lifter and PZ tile lifter and SAH block excavator	41800001
Flügelschraube Wing screw 	Flügelschraube M 10 x 50 Wing screw M 10 x 50	20060004
Flügelmutter Wing nut 	M 10 Flügelmutter M 10 Wing nut	20160004
Messerbefestigung Blade fixing 	Zylinderschraube M 8 x 50 Cylinder screw M 8 x 50	20020082
Messerbefestigung Blade fixing 	Sechskantmutter M 8 Hex nut M 8	20100015
Handgriff Handle 	PVC-Handgriff 3/4" PVC-handle 3/4"	21600016





Steinziehhammer / Block Extractor Hammer SZH

Artikel / Article	Beschreibung / Description	Best.-Nr. / Order-Number
Satz Schrauben Screw Set	 Satz à 6 x 80, 100 Stück Set of 6 x 80, 100 pc	41800239
Handgriffe Handle	 Kunststoff-Handgriffe, rot PVC-handle, red	21600016



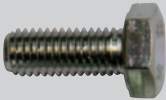

Richteisen RE / Mehrfachrichteisen MRE / Alignment Bar RE / Multiple Alignment MRE

Artikel / Article	Beschreibung / Description	Best.-Nr. / Order-Number
Messer Blade	 Ersatzmesser für Richteisen RE / MRE Replacement blade for RE / MRE	41800002
Messerbefestigung Blade fixing	 Sechskantschraube M 10 x 25 Hex screw M 10 x 25	20000017
Messerbefestigung Blade fixing	 Sechskantmutter M 10 Hex nut M 10	20100016
Handgriffe Handle	 PVC-Handgriff 3/4" PVC-handle 3/4"	21600016



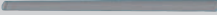

Gummihammer / Rubber Hammer GH/GH-K

Artikel / Article	Beschreibung / Description	Best.-Nr. / Order-Number
Ersatz-Gummi für GH/GH-K Rubber cover for GH/GH-K 	Gummi für Gummihammer, schraubbar, 2 Gewinde M8 Rubber for GH rubber mallet, screwable, 2 M8 threads	41800006
Stiel, lang Handle, long 	Holzstiel für Gummihammer GH, Esche, 800 mm Wooden handle for rubber mallet GH, ash, 800 mm	41800231
Stiel, kurz Handle, short 	Holzstiel für Gummihammer GH-K, Esche, 400 mm Wooden handle for rubber mallet GH-K, ash, 400 mm	41800052





Gummihammer / Rubber Hammer GH-ERGO / GH-ERGO-K

Artikel / Article	Beschreibung / Description	Best.-Nr. / Order-Number
Ersatz-Gummi flach Rubber cover flat 	Gummi schraubbar flach Rubber cover flat	36330328
Ersatz-Gummi spitz Rubber cover pointy 	Gummi schraubbar spitzig Rubber cover pointy	36330327
PVC Schutzscheibe PVC protective disc 	PVC Schutzscheibe 70x12 mm PVC protective disc 70x12 mm	33250280







Gummihammer / Rubber Hammer GH-ERGO / GH-ERGO-K

Artikel / Article	Beschreibung / Description	Best.-Nr. / Order-Number
Stiel lang Handle long	 Holzstiel 1000 mm Wooden handle 1000 mm	41800249
Stiel kurz Handle short	 Holzstiel 400 mm Wooden handle 400 mm	41800052





STONE SPLITTER STS-33 / STS-33-F / STS-33-EASY

Artikel / Article	Beschreibung / Description	Best.-Nr. / Order-Number
Linsenschrauben Oval-head screw	 Linsenschrauben M8x10 Oval-head screw M8x10	20070016
Rad Wheel	 Vollgummirad 125-37 Wheel 125-37	21820001
Scheibe Washer	 Scheibe DIN 125 Washer DIN 125	20400005
Messer Blade	 Messer 330 mm für STS-33 Blade 330 mm für STS-33	33000029



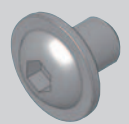

STONE SPLITTER STS-43 / STS-43-H / STS-43-EASY / STS-43-H-EASY

Artikel / Article	Beschreibung / Description	Best.-Nr. / Order-Number
Messer Blade	 Messer 430 mm Blade 430 mm	33000030
Linsenschrauben Oval-head screw	 Linsenschrauben M8x10 Oval-head screw M8x10	20070016
Rad Wheel	 Vollgummirad 160/40 Wheel 160/40	21820003
Scheibe Washer	Scheibe DIN 125 Washer DIN 125	20400006





STONE SPLITTER STS-65 / STS-65-H / STS-65-EASY

Artikel / Article	Beschreibung / Description	Best.-Nr. / Order-Number
Messer Blade	 Messer 330 mm (Bedarf 4 St.) Blade 330 mm (req. 4 pc.)	33000029
Linsenschrauben Oval-head screw	 Linsenschrauben M8x10 Oval-head screw M8x10	20070016
Rad Wheel	 Vollgummirad 160/40 Wheel 160/40	21820003
Scheibe Washer	Scheibe DIN 125 Washer DIN 125	20400006



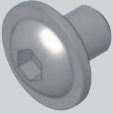



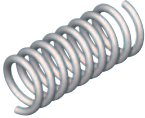

Elektrohydraulischer Steinknacker / Electro-Hydraulic Block Splitter STONE SPLITTER STS-43-EH-23

Artikel / Article	Beschreibung / Description	Best.-Nr. / Order-Number
Messer Blade	 Messer (34 Stück eingebaut) Replacement blade 25 mm	33000035
Linsenschraube Oval head screw	 Für Messerbefestigung Oval head screw	20070016
Auflagetisch Support plate	 Auflageblech Support plate	41200120



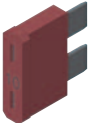

Elektrohydraulischer Steinknacker / Electro-Hydraulic Block Splitter STONE SPLITTER STS-43-EH-23

Artikel / Article	Beschreibung / Description	Best.-Nr. / Order-Number
Druckfeder Spring	 für Auflagetisch Spring for support plate	21700092
Ersatzrad Spare wheel	 Ersatzrad mit Bremse Spare wheel with brake	21820013
Ersatzrad Spare wheel	 Ersatzrad ohne Bremse Spare wheel without brake	21820002
Rad Wheel	 Rad Hinterachse Wheel rear axle	21820024
Handgriff Handle	 PVC-Handgriff 1/2" PVC-Handle 1/2"	21600005
HD-Schlauch HD hose	 von Pumpe zu Oberteil HD hose from pum to top part	22000854
Batterie Battery	 12V Battery 12V	24200153
Hebel Level	 Hebel zu Batterieauptschalter Level battery switch	24110002
Drucktaster Push button	 Taster für Bedienung Push button function	41500033
Sicherung Fuse	 Streifensicherung 80A Fuse 80A	24120040
Sicherung Fuse	 Flachsicherung 10A Fuse 10A	24100313



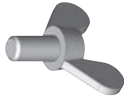

Elektrohydraulischer Steinknacker / Electro-Hydraulic Block Splitter STONE SPLITTER STS-43-EH-23

Artikel / Article	Beschreibung / Description	Best.-Nr. / Order-Number
Schraube Screw	 Flügelschraube zu Batteriedeckel Wing screw battery cover	20060027
Handgriff Handle	 auf Batteriekasten Handle battery box	21600052



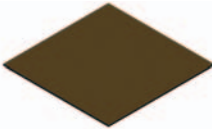
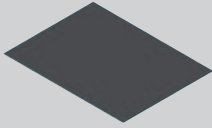

SAFEFLEX SF

Artikel / Article	Beschreibung / Description	Best.-Nr. / Order-Number
Antirutschmatte Anti-slip mat	 Auflagematte für Steinauflage Anti-slip mat under stone	41210004
Antirutschmatte Anti-slip mat	 Auflagematte für Fußtritt Anti-slip mat footarea	41210005
Gummipuffer Rubber buffers	 Gummipuffer Anschlag Rubber buffers	21070018





VAKUUM-HANDY VH-1/25

Artikel / Article	Beschreibung / Description	Best.-Nr. / Order-Number
Ersatzdichtung Replacement seal	 Ersatzdichtung für VAKUUM-HANDY Replacement seal for VACUUM-HANDY	42730008
Dichtstreifen Sealing strip	 Dichtstreifen für VAKUUM-HANDY aus Vulkolan Sealing strip for VACUUM-HANDY in Vulkolan	36600019
Handgriffe Handle	 PVC-Handgriff 3/4" PVC-handle 3/4"	21600016



FLIEGUAN-AKKU-HANDY FXAH-120-GRABO

Artikel / Article	Beschreibung / Description	Best.-Nr. / Order-Number
Ersatzdichtung Replacement seal	 Dichtring Replacement seal	48500037
Ansaugfilter Filter	 2er Pack Filter Filter (2pc.)	48500038
Akku Battery	 Ersatz oder Zusatzakku Battery	24200144



FLIEGUAN-AKKU-HANDY FXAH-120-GRABO

Artikel / Article	Beschreibung / Description	Best.-Nr. / Order-Number
Ladegerät Charger 	Ladegerät Charger	24200159
Schalter Switch 	Grüner Schalter Switch	24110222
Hauptschalter Main switch 	Ein Aus Schalter mit Platine (nicht für PRO) Main switch on/off not for PRO version	48500049
Manometer 	Vakuummanometer Vacuum manometer	22130035
Federriegel Spring bolt 	Für FXAH Adapter Spring bolt for handle	20540052



AIRLIFT ALX-120

Artikel / Article	AL-43/SH-21	Best.-Nr. / Order-Number
Vakuumschlauch Vacuum hose	 Vakuumschlauch 1,5 m Vacuum hose 1.5 m	25210016
Filter	 Gewebefilterbeutel Fabric filter bag	25000085
Filter	 Papierfilter Paper filter	25000086
Verlängerungskabel Extension cable	 Verlängerungskabel 15 m Extension cable 15 m	24100497
Rückentragegeschirr Backpack harness	 für ALX for ALX	42600175
Schwammgummi Sponge rubber	 für ALX-ESP (Meterware) for ALX-ESP (by the meter)	42101448









VAKUUM-POWER-HANDY VPH-GREENLINE

Artikel / Article	Beschreibung / Description	Best.-Nr. / Order-Number
VPH-Batterie VPH battery	 Blockbatterie GIV, 6,5 Ah, 12 V, 151 x 65 x 99 mm, für VPH GIV block battery, 6.5 Ah, 12 V, 151 x 65 x 99 mm, for VPH	24200007
VPH-Filter VPH filter	 Ansaugfilter für VPH/SM-2, Dm 42 mm Suction filter for VPH/SM-2, Dm 42 mm	42710004
VPH-Filter VPH filter	 Innenfilter Internal filter	42710020
VPH-Ladegerät VPH charger	 Steckerladegerät 220 V/12 V/6 V/600 mA für VAKUUM-POWER-HANDY VPH 220 V/12 V/6 V/600 mA plug-in charger for VPH vacuum power handy	24200004
Vakuummanometer Vacuum manometer	 Vakuummanometer Vacuum manometer	22130019
Wippschalter Rocker switch	 1-teilig mit angespritzter Schutzkappe 1-part with sprayed protective cap	24120018
Schutzkappe Protective cap	 für Wippschalter VPH/SM for rocker switch VPH/SM	24100162
VPH Dichtring VPH sealing ring	 VPH-ED-SPS-100	42730004
VPH Dichtring VPH sealing ring	 VPH-ES-SPS-150	42730012
Vakuumpumpe Vacuum pump	 Vakuumpumpe 12 V Vacuum pump 12 V	25300030
Vakuumschlauch Vacuum hose	 Vakuumschlauch, Bedarf ca. 1 m (Meterware) requirement approx. 1 m (goods by meter)	23000011



Vakuum-Plattenverlegehilfe / Vacuum Slab Layer MIKROJUMBO MJ-I-75 / MJ-II-150

Artikel / Article	Beschreibung / Description	Best.-Nr. / Order-Number
MJ-HTG-I	 HTG-I - Handtragegriff für MJ-I HTG-I - carry handle for MJ-I	42700001
MJ-HTG-II	 HTG-II - Handtragegriff für MJ-II HTG-II - carry handle for MJ-II	42700002
MJ-Zuführschlauch MJ feed hose	 Zuführschlauch für MJ zwischen VPE und MJ Feed hose for MJ	42700003
MJ-SPS	 MJ-ED-SPS-75	42700008
MJ-SPS	 MJ-ED-SPS-150	42700009
Dichtlippe Sealing lip	 Dichtlippe Vulkolan zum Ablösen Vulkolan sealing lip for removal	36600003
Vakuumschlauch Vacuum hose	 Vakuumschlauch, Bedarf ca. 1,4 m (Meterware) Requirement approx. 1.4 m (goods by meter)	25210008

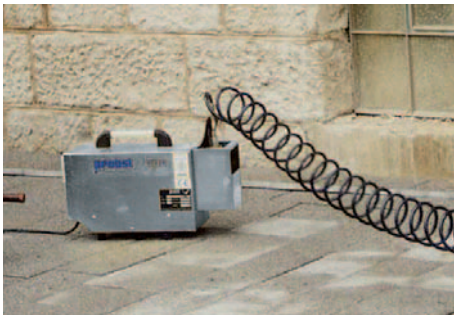

Vakuum-Pumpen-Einheit / Vacuum Pump Unit VPE

Artikel / Article	Beschreibung / Description	Best.-Nr. / Order-Number
Reparaturset Repair set 	Kolbendichtung und Zylinderbuchse Piston seal and cylinder bush	42400029
Luftfilter kpl. mit Gehäuse Air filter complete with casing 	3/4" für JUMBO SH und VPE inkl. Polyester Filterpatrone C 75 Poly 3/4" for JUMBO SH and VPE incl. polyester Filter cartridge C 75 Poly	42500121
Luftfilter Air filter 	Luftfiltereinsatz C 75 Air filter insert	42500120
Kondensator Air filter insert 	Kondensator zu Elektromotor Air filter insert	24070002
Filtermatte Air filter insert 	Filtermatte 170 x 145 Filter mat 170 x 145	25050017
Ansaugfilter Suction filter 	Ansaugfilter mit schwarzem Kunststoffgehäuse Suction filter with black plastic housing	25000034
Netzkabel Mains cable 	Anschlusskabel 2 m Electric cable 2 m	42400559



Vakuum-Handverlegegerät / Vacuum Hand Laying Device SPEEDY VS

Artikel / Article	Beschreibung / Description	Best.-Nr. / Order-Number
Speedy-Bowdenzug Speedy Bowden cable	 Bowdenzug komplett für SPEEDY VS Bowden cable complete for SPEEDY VS	21000157
Wippschalter Rocker switch	 Wippschalter 1-teilig Rocker switch 1-piece	24120018
Kondensator Condenser	 Kondensator zu Speedy Condenser for Speedy	42710062
Vakuum-Manometer Vacuum manometer	 Vakuum-Manometer Vacuum manometer	22130016
Belüftungsklappe Ventilation flap	 Belüftungsklappe mit Verstärkung Ventilation flap, with reinforcement	42710147
Klettverschluss Velcro fastener	 für EP-UNI / SPEEDY, für Kabelbefestigung for EP-UNI / SPEEDY, for cable mounting	21060014
Betätigungshebel Actuating lever	 Handgriff zum Belüften für SPEEDY VS Actuating lever as ventilation for SPEEDY VS	42710036
Federsteckbolzen Spring plug bolt	 1/2" für SPEEDY VS, Handgriffverstellung Sword-Pin 1/2" for SPEEDY VS, handle adjustment Sword pin	42710052
Netzkabel Mains cable	 mit Stecker für SPEEDY VS with plug for SPEEDY VS	24100369
Druckfeder 1.50 Compression spring 1.50	 für SPEEDY VS for SPEEDY VS	42710058
VS-Dichtring VS-sealing ring	 VS-ED-SPS-50	42710032



Vakuum-Handverlegegerät / Vacuum Hand Laying Device SPEEDY VS

Artikel / Article	Beschreibung / Description	Best.-Nr. / Order-Number
VS-Dichtring VS-sealing ring	 VS-ED-SPS-80	42710029
VS-Dichtring VS-sealing ring	 VS-ED-SPS-100	42710031
VS-Dichtring VS-sealing ring	 VS-ED-SPS-140	42710030
VS-Dichtring VS-sealing ring	 VS-ED-SPS-200	42710140
Abdeckkappe Cover cap	 Abdeckkappe rund für Schlauchanschluss Cover cap round for hose connection	21070118
Befestigungsset Gebläse Fan fixing set fan	 Befestigungsset bestehend aus: 4 Schrauben/4 Kunststoffabdeckungen Fixing set includes: 4 screws / 4 plastic covers	42710115
SPEEDY-Gebläse SPEEDY fan	 Gebläse/Motor 230 V mit Gehäuse inkl. Befestigungsset ab ca. Bj.02/2020 Fan/Motor 230 V with housing incl. fixing set from yc.02/2020	42710175
SPEEDY-Gebläse SPEEDY fan	 Gebläse/Motor 230 V ohne Gehäuse inkl. Befestigungsset Fan/motor 230 V with no housing incl. fixing set	42710145
Klettverschluss Velcro fastener	 Klettverschluss für Gebläsedeckel, Bedarf 0,15 m (Meterware) Velcro fastener for fan cover, Requirement 0.15 m (goods by meter)	21060034
Dichtring für Gebläse Sealing ring for fan	 Dichtring schwarz Sealing ring black	42710059
Grobfilter Coarse filter	 Maschendraht Grobfilter Wire mesh coarse filter	33080100



Vakuum-Handverlegegerät / Vacuum Hand Laying Device SPEEDY VS

Artikel / Article	Beschreibung / Description	Best.-Nr. / Order-Number
Befestigungsset Saugplatte Fixing set suction plate 	Befestigungsset bestehend aus: 4 Schrauben/4 Kunststoffabdeckungen/ 4 Unterlegscheiben Fixing set includes: 4 screws / 4 plastic covers / 4 washers	42710112
Umbausatz SPEEDY Saugplatte SPEEDY conversion set suction plate 	Nachrüstset bestehend aus: Gegenhalter, Schrauben, Muttern und Schablone für Schnellwechselplatte Retrofit kit includes: counter-holder, screws, nuts and template for quick change device	42710127
Abdeckstopfen Saugplatte Cover stoppers suction plate 	Lamellenstopfen für Saugplatte Lamellar stoppers for suction plate	21070141
Schwammgummi Schnellwechselsaugplatte Sponge rubber Quick change device 	Schwammgummi rot, 30/25 Meterware (Klebstoff erforderlich) Sponge rubber red, 30/25 goods by meter (adhesive required)	42100024
Klebstoff für Schwammgummi Adhesive for Sponge rubber 	Doppelseitiges Klebeband, 50 m Rolle Double-sided adhesive tape, 50 m roll	29050103
Kette Chain 	Kette für Kettensicherung Chain for Kettensicherung	21000261
V-Ring V-ring 	Dichtung zwischen Trägergerät und Saugplatte Seal ring between suctionplate and speedy	42710010











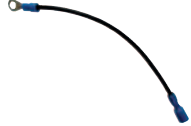

Vakuum-Anbaugerät / Vacuum Lifting Device STEINMAGNET SM-400 / SM-600-GREENLINE / SM-600-GREENLINE-POWER

Artikel / Article	Beschreibung / Description	Best.-Nr. / Order-Number
Akku Battery 	Ersatz-Akku 12 V / 26 Ah Replacement battery 12 V / 26 Ah	24200008
Blitzleuchte Flashing light 	Warnleuchte 12 V Warning light 12 V	24180009
Druckschalter Pressure switch 	Druckschalter schwarz für Pumpensteuerung Pressure switch black for pump control	22900003
Druckschalter Pressure switch 	Druckschalter rot für Warneinrichtung Pressure switch red for warning device	22900004
Vakuumpumpe Vacuum pump 	Pumpe komplett mit Einbausatz für SM-400 / SM-600 Pump complete with installation set for SM-400 / SM-600	25300054
Vakuumpumpe Vacuum pump 	Pumpe für SM-600-POWER FFS / SM-600-POWER Pump for SM-600-POWER FFS / SM-600-POWER	25300061
Ansaugfilter Suction filter 	Ansaugfilter Suction filter	42710004
Silikonschlauch Silicone hose 	Silikonschlauch Meterware 6 x 3 Silicone hose goods by meter 6 x 3	42720027
Schalter Switch 	Ein/Aus-Schalter, 2-stufig On/off switch, 2-stage	24110032
Taster Button 	Drucktaster weiß für Ansaugen SM-600-POWER FFS / SM-600-POWER Push button white for suction SM-600-POWER FFS / SM-600-POWER	24110054
Taster Button 	Drucktaster rot für Lösen SM-600-POWER / SM-600-POWER FFS Push button red for release SM-600-POWER / SM-600-POWER FFS	24110181



Vakuum-Anbaugerät / Vacuum Lifting Device STEINMAGNET SM-400 / SM-600-GREENLINE / SM-600-GREENLINE-POWER

Artikel / Article	Beschreibung / Description	Best.-Nr. / Order-Number
LED Ladespannungsanzeige Platine LED charging voltage display circuit board	 Ladespannungsanzeige für SM-400 bis 04/2010 (runde LED's) Charging voltage display for SM-400 until 04/2010 (round LEDs)	24360007
LED Ladespannungsanzeige LED charging voltage display	 Ladespannungsanzeige für SM-400 ab 04/2010 + alle SM-600 Varianten Charging voltage display for SM-400 from 04/2010 + all SM-600 variants	24360019
Kette Chain	 Kette für alle SM-600 Varianten, Bedarf 3 m Chain for all SM-600 variants, Requirement 3 m	21000009
Batteriekabel Battery lead	 Batteriekabel rot 15 cm komplett für SM-400 Battery lead red 15 cm complete for SM-400	42720333
Batteriekabel Battery lead	 Batteriekabel schwarz 15 cm komplett für SM-400 Battery lead black 15 cm complete for SM-400	42720334
Batteriekabel Battery lead	 Batteriekabel mit Stecker für alle SM-600 Varianten Battery lead with plug for all SM-600 variants	42720355
Dichtring Sealing ring	 Ersatzdichtring SPS-90 (1375) Replacement sealing ring SPS-90 (1375)	42500023
Dichtring Sealing ring	 Ersatzdichtring SPS-200 (1376) Replacement sealing ring SPS-200 (1376)	42720004
Dichtring Sealing ring	 Ersatzdichtring SPS-400 (1381) Replacement sealing ring SPS-400 (1381)	42720005
Dichtring Sealing ring	 Ersatzdichtring SPS-600 (1072) Replacement sealing ring SPS-600 (1072)	42500027
Gummiband Rubber band	 Gummiband Batteriebefestigung für SM-400 Rubber band battery fixing for SM-400	42720251



Vakuum-Anbaugerät / Vacuum Lifting Device STEINMAGNET SM-400 / SM-600-GREENLINE / SM-600-GREENLINE-POWER

Artikel / Article	Beschreibung / Description	Best.-Nr. / Order-Number
Schauglas Sight glass	 Schauglas für Vakuumtank Sight glass for vacuum tank	42720195
Abluftfilter Exhaust filter	 Abluftdämpfer für SM-400 Exhaust silencer for SM-400	23080002
Abluftfilter Exhaust filter	 Abluftdämpfer für SM-600 Exhaust silencer for SM-600	23080017
Handschiebeventil Manual slide valve	 Handschiebeventil für SM-600 Manual slide valve for SM-600	23071001
Handschiebeventil Manual slide valve	 Handschiebeventil für SM-400 Manual slide valve for SM-400	23070007
Manometer	 Vakuum-Manometer Vacuum manometer	22130015
Kugelhahn Ball valve	 Kugelhahn Kondenswasserentleerung Condensation drainage ball valve	22060009
Lastsicherungskette Chain	 Nachrüstset Lastsicherungskette Chain box	42720348



Vakuum-Anbaugerät / Vacuum Lifting Device QUICKJET QJ-600-E

Artikel / Article	Beschreibung / Description	Best.-Nr. / Order-Number
Abdeckkappe Cover cap 	Abdeckkappe rund für Schlauchanschluss Cover cap round for hose connection	21070109
Befestigungsset Gebläse Fan fixing set 	Befestigungsset bestehend aus: 4 Schrauben/ 4 Kunststoffabdeckungen Fixing set includes: 4 screws / 4 plastic covers	42710115
Ansaugsieb Suction strainer 	Maschendrahtgitter 120 x 120 Wire netting 120 x 120	33080100
Ansaugsieb Suction strainer 	Befestigungsgitter für Maschendraht Fixing grill for wire mesh	33503130
QJ-Gebläse QJ fan 	Gebläse/Motor 230 V mit Gehäuse inkl. Befestigungsset ab ca. Bj.02/2020 Fan/Motor 230 V with housing incl. fixing set from yc.02/2020	42710175
QJ-Gebläse QJ fan 	Gebläse/Motor 230 V ohne Gehäuse inkl. Befestigungsset Fan/motor 230 V with no housing incl. fixing set	42710145
Netzkabel Power cord 	Netzkabel mit Stecker für Gebläse Power cord with plug	24100369
Manometer Vacuum manometer 	Vakuum-Manometer Vacuum manometer	22130016
Kabel Cable 	Kabelverlängerung mit Ein/Aus Schalter Cable extension with on/off switch	42420015
Einhängenhaken Mounting hook 	Einhängenhaken für Verschlussspanner Mounting hook for closing tensioner	21060008
Einhängenhaken Mounting hook 	Einhängenhaken inkl. Verschlussspanner Mounting hook incl. closing tensioner	21060023









Vakuum-Anbaugerät / Vacuum Lifting Device QUICKJET QJ-600-E

Artikel / Article	Beschreibung / Description	Best.-Nr. / Order-Number
Kette Chain	 Sicherungskette 3,8 m Safety chain 3.8 m	21000285
Zündkerze Spark plug	 Zündkerze für Stromerzeuger Honda EU 20i/EU 22i Spark plug for Honda EU 20i/EU 22i	26910012
Luftfilter Air filter	 Luftfilter für Stromerzeuger Honda EU 20i/EU 22i/Kipor Air filter for Honda EU 20i/EU 22i/Kipor	26900053
Luftfilter Air filter	 Vorfilter/ Grobfilter Luft für Stromerzeuger Honda EU 20i/EU 22i/Kipor Air pre-filter for Honda EU 20i/EU 22i/Kipor	26900054
Zündkerze Spark plug	 Zündkerze für Stromerzeuger Kipor Spark plug for Kipor	26910008
Befestigung Stromerzeuger Fixation for generator	 O-Ring 160x9	40110124
Schwammgummi Foam rubber	 Schwammgummi 30x25 Foam rubber 30x25	42100024
Klebeband Tape	 Klebeband für Schwammgummi (50 m Rolle) Adhesive tape for sponge rubber (50 m)	29050162
Betätigungshebel Operationg lever	 Betätigungshebel mit Verriegelung Operationg lever with lock	21600064
Bowdenzug Bowden cable	 Bowdenzug Bowden cable	21000157
Belüftungsklappe Ventilation flap	 Belüftungsklappe Ventilation flap	42710147

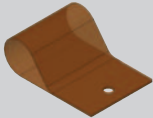

MICROJUMBO-JET MJ-J Vakuum-Plattenverlegehilfe / Vacuum Slab Layer

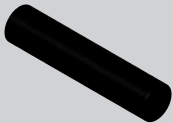
Artikel / Article	Beschreibung / Description	Best.-Nr. / Order-Number
Anschlusskonus Connection cone 	Anschlusskonus für Staubsauger Ø 44 – Ø 67 mm Connection cone Ø 44 – Ø 67 mm	33320100
Anschlusskonus Connection cone 	Anschlusskonus für Staubsauger Ø 35 – Ø 70 mm Connection cone Ø 35 – Ø 70 mm	33320101
Halterung Mounting 	Halterung für Konus inkl. Gummi Expander Mounting with rubber expander	48500013
Vakuumschlauch Vacuum hose 	Schlauch Ø 32 mm, L: 5 m Vacuum hose Ø 32 mm, L: 5 m	48500011
Dichtring Seal ring 	Dichtring Nr. 1375, 20 x 20 mit Schwamm Seal ring Nr. 1375, 20 x 20	42500026
Dichtstreifen Rubber flap 	Dichtstreifen aus Vulkolan Rubber flap	36600039
Handgriff Handle 	Handgriff schwarz, beidseitig offen Handle, black, double-side open	21600060
Handgriff Handle 	Handgriff schwarz, einseitig offen Handle, black, one-side open	21600061



FLIEGUAN-ERGO-STICK FXES-25 Fliesen- und Platten- Verlegegerät / Tile and Slab Laying Device

Artikel / Article	Beschreibung / Description	Best.-Nr. / Order-Number
Anschlusskonus Connection cone 	Anschlusskonus für Staubsauger Ø 44 – Ø 67 mm Connection cone Ø 44 – Ø 67 mm	33320100
Anschlusskonus Connection cone 	Anschlusskonus für Staubsauger Ø 35 – Ø 70 mm Connection cone Ø 35 – Ø 70 mm	33320101
Halterung Mounting 	Halterung für Konus inkl. Gummi Expander Mounting with rubber expander	48500013
Vakuumschlauch Vacuum hose 	Schlauch Ø 32 mm, L: 5 m Vacuum hose Ø 32 mm, L: 5 m	48500011
Dichtstreifen Rubber flap 	Vulkolan Dichtstreifen Rubber flap	36600039
Dichtring Seal ring 	Dichtring Nr. 1496 Seal ring Nr. 1496	42500129
Rad Wheel 	Vollgummirad Ø 125 Wheel Ø 125	21820005



Vakuum-Anbaugerät / Vacuum Lifting Device SH-1000-MINI

Artikel / Article	Beschreibung / Description	Best.-Nr. / Order-Number
Warneinrichtung Alarm 	Warneinrichtung 12 x 8 x 7 Alarm 12 x 8 x 7	42500190
Warneinrichtung Alarm 	Warneinrichtung 24 x 12 x 11 Alarm 24 x 12 x 11	42500056
Federriegel Spring lock 	Federriegel mit Mutter M 18 für alle SH-1000-Mini Versionen Spring lock with nut M 18 for all SH-1000-Mini versions	20540024
Vakuumzuführschlauch Vacuum feed hose 	Vakuumzuführschlauch DN 13, Meterware für alle SH-1000-Mini Versionen Vacuum feed hose DN 13, meter goods for all SH-1000-Mini versions	25210008
Luftfilter Vakuum Air filter vacuum 	Filterpatrone C75 für Luftfilter für alle SH-1000-Mini Versionen Filter cartridge C75 for air filter for all SH-1000-Mini versions	42500120
Manometer 	Vakuum Manometer für alle SH-1000-Mini Versionen Vacuum Manometer for all SH-1000-Mini versions	22130018
Schutzschalter für E-Versionen Protection switch for E-versions 	Motorschutzschalter inkl. Hauptschalter und Gehäuse Motor protection switch incl. master switch and housing	42400001
Anschlusskupplung Connection coupling 	Geka Anschlusskupplung für Saugplatte für alle SH-1000-Mini Versionen Geka connection coupling for suction plate for all SH-1000-Mini versions	23220008
Zündkerze für B-Version Spark plug for B-Version 	Zündkerze für SH-1000-MINI-B Spark plug for SH-1000-MINI-B	26910009
Luftfilter für B-Version Airfilter for B-Version 	Luftfilter für SH-1000-MINI-B Airfilter for SH-1000-MINI-B	26900039







Vakuum-Anbaugerät / Vacuum Lifting Device SH-1000-MINI

Artikel / Article	Beschreibung / Description	Best.-Nr. / Order-Number
Reparatursatz H-Version Repair kit H-Version 	Reparatursatz Vakuumpumpe Repair kit vacuum pump	42400029
Lastsicherungskette Security chain	Nachrüst-Set Lastsicherungskette Security chain kit	42400614



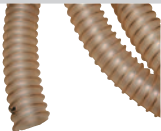

Vakuum-Anbaugerät / Vacuum Lifting Device POWERJET PJ-1650-B

Artikel / Article	Beschreibung / Description	Best.-Nr. / Order-Number
Manometer 	Vakuum-Manometer Vacuum manometer	22130029
Filter 	Vakuum Filtereinsatz Ersatzfilterelement Vacuum filter insert replacement filter element	26900020
Luftfilter Air filter 	Luftfilter Honda-Motor Air filter for Honda motor	26140022
Keilriemen V-belt 	Schmalkeilriemen 10 x 1060 (Bedarf: 2 Stück) 10 x 1060 narrow V-belt (requirement: 2 units)	21100068
Zuführschlauch Feed hose 	Zuführschlauch Meterware Feed hose by meter	25200014







Vakuum-Anbaugerät / Vacuum Lifting Device POWERJET PJ-1650-B

Artikel / Article	Beschreibung / Description	Best.-Nr. / Order-Number
Zündkerze Spark plug	 Zündkerze Spark plug	26910009
Batterie Battery	 Batterie für Warneinrichtung (VPE 2 Stück) Battery for warning device (VPE 2 units)	69110004



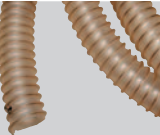









Vakuum-Anbaugerät / Vacuum Lifting Device POWERJET PJ-1650-H

Artikel / Article	Beschreibung / Description	Best.-Nr. / Order-Number
Manometer	 Vakuum-Manometer Vacuum manometer	22130029
Filter	 Vakuum Filtereinsatz Ersatzfilterelement Vacuum filter insert replacement filter element	26900020
Batterie Battery	 Batterie für Warneinrichtung (VPE 2 Stück) Battery for warning device (VPE 2 units)	69110004
Zuführschlauch Feed hose	 Zuführschlauch, Meterware Feed hose, by meter	25200014
Keilriemen V-Belt	 Schmalkeilriemen, 1037 mm lang (Bedarf: 2 Stück) V-belt, 1037 mm (2 pieces required)	21100064



Vakuum-Anbaugerät / Vacuum Lifting Device SH-2500-UNI-B

Artikel / Article	Beschreibung / Description	Best.-Nr. / Order-Number
Filter 	Filterpatrone Luffilter C75 Air filter C 75 filter cartridge	42500120
Batterie Battery 	Trockenbatterie 6V 6V dry battery	24200010
Keilriemen V-belt 	Keilriemen V-belt	21100002
Zuführschlauch Feed hose 	Vakuum Zuführschlauch (Meterware) Vacuum feed hose (by meter)	25210008
Zündkerze Spark plug 	Zündkerze Spark plug	26910009
Luffilter Air filter 	Luffilter Einsatz für GX120, ältere Version Air filter insert for GX120	25000029
Luffilter Air filter 	Luffilter Einsatz (oval) für GX120 Air filter insert (oval) for GX120	26900039
Manometer 	Vakuum Manometer Vacuum Manometer	22130008
Warneinrichtung Alarm 	für SH akustisch-elektronisch 8 x 12 x 7 for SH acoustic-electronic 8 x 12 x 7	42500190
Pumpe Pump 	Vakuumpumpe TFK12 Vacuum pump TFK12	25300021
Kohleschieber Set Carbon gate valve set 	Kohleschieber, 68 mm lang, 6 Stück Carbon gate valve set, 68 mm long, 6 units	25350006





Vakuum-Anbaugerät / Vacuum Lifting Device SH-2500-UNI-B

Artikel / Article	Beschreibung / Description	Best.-Nr. / Order-Number
Handschiebeventil Manual slide valve 	Handschiebeventil für Vakuumsteuerung Manual slide valve for vacuum control	23070010
Kohlescheibe Carbon disc 	Kohlescheibe für Pumpe Carbon disc for pump	20400099
Schalldämpferpumpe Silencer pump 	Schalldämpfer mit Metallgehäuse Silencer with metal housing	42400081
Lastsicherungskette Security chain 	Nachrüstset Lastsicherungskette Security chain kit	42400611



Vakuum-Anbaugerät / Vacuum Lifting Device SH-2500-UNI-GREENLINE

Artikel / Article	Beschreibung / Description	Best.-Nr. / Order-Number
Filter 	Filterpatrone Luftfilter C75 Air filter C75	42500120
Manometer 	Vakuum Manometer Vacuum manometer	22130008
Li-Ion-Akku 	Li-Ion-Akku 24 V / 23 Ah	24200142
Vakuum Pumpe Vacuum pump	Vakuum Pumpe für SH-2500-UNI-GREENLINE Vacuum pump for SH-2500-UNI-GREENLINE	25300077







Vakuum-Anbaugerät / Vacuum Lifting Device SH-2500-UNI-E

Artikel / Article	Beschreibung / Description	Best.-Nr. / Order-Number
Filter 	Filter für Pumpe Filter for pump	25000010
Filter 	Filterpatrone Luftfilter C75 Air filter C 75 filter cartridge	42500120
Manometer Manometer 	Vakuum Manometer Vacuum manometer	22130008
Zuführschlauch Feed hose 	Vakuum Zuführschlauch (Meterware) Vacuum feed hose (by meter)	25210008
SH-UNI-Motorschalter SH-UNI-motor switch 	Motorschutzschalter CGFM2TB S-Nr. 21.01.02.00034 CGFM2TB S-no. 21.01.02.00034 motor circuit breaker	42400001
Warneinrichtung Alarm 	Warneinrichtung 8 x 8 x 8,5 Alarm 8 x 8 x 8,5	42500086
Verbindungskabel Connecting cable 	Anschlusskabel 1,5 m Connector cable 1.5 m	24100005
Lastsicherungskette Security chain 	Nachrüstset Lastsicherungskette Security chain kit	42400611
Vakuum Pumpe Vacuum pump 	Verschleißteilsatz für Pumpe Wear parts for pump	25300012

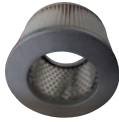

Vakuum-Anbaugerät / Vacuum Lifting Device SH-2500-UNI-B-TURBO

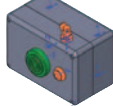
Artikel / Article	Beschreibung / Description	Best.-Nr. / Order-Number
Manometer 	Vakuum Manometer Vacuum manometer	22130005
Zuführschlauch Feed hose 	Vakuum Zuführschlauch (Meterware) Vacuum feed hose (by meter)	25200011
Filter 	Filtereinsatz für Vakuum-Filter Micro Top E Filter insert for Micro Top E vacuum filter	25000048
Filter 	Luftfiltereinsatz für Honda-Motor Air filter insert for Honda engine	26110034
Warneinrichtung Alarm 	Warneinrichtung 8 x 12 x 7 Alarm 8 x 12 x 7	42500190
Keilriemen V-belt 	Keilriemen (Bedarf: 2 Stück) V-belt (requirement: 2 units)	21100012
Zündkerze Spark plug 	Zündkerze Spark plug	26910009







Vakuum-Anbaugerät / Vacuum Lifting Device SH-3500-B

Artikel / Article	Beschreibung / Description	Best.-Nr. / Order-Number
Kette Chain	 Kette für Kettensicherung Chain	21000321
Keilriemen V-belt	 Keilriemen V-belt	21100005
Filter	 Filterpatrone Luftfilter C75 Air filter C75	42500120
Akku Battery	 Ersatzakku 12 V/26 Ah Replacement battery 12 V/26 Ah	24200008
Zuführschlauch Feed hose	 Vakuum Zuführschlauch Ø 25 mm (Meterware) Vacuum feed hose Ø 25 mm (by the meter)	25200010
Zuführschlauch Feed hose	 Vakuum Zuführschlauch Ø 32 mm (Meterware) Vacuum feed hose Ø 32 mm (by the meter)	25200017
Luftfilter Air filter	 Luftfilter Einsatz für GX 160 Air filter insert for GX 160	26110034
Zündkerze Spark plug	 Zündkerze Spark plug	26910009
Filter	 Ölfilter Oil filter	25300046
Manometer	 Vakuum Manometer Vacuum manometer	22130008

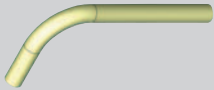

Vakuum-Anbaugerät / Vacuum Lifting Device VAKUUM-POWER-MAX VPM-2500

Artikel / Article	Beschreibung / Description	Best.-Nr. / Order-Number
Wechselautomatik Automatic changer	Einsatz für Wechselautomatik kompl. Insert for automatic changer compl.	40110036
Filter	 Öfilter Kartusche Oil filter cartridge	25000016
Filter	 Vakuum Filter Einsatz Vacuum filter insert	25000048
Zuführschlauch Feed hose	 Vakuum Zuführschlauch (Meterware) Vacuum feed hose (by meter)	25200011
Warneinrichtung Alarm	 für SH akustisch-elektronisch for SH acoustic-electronic	42500190







Vakuum-Bordsteinverlegegerät / Vacuum Kerb Stone Installation Machine JUMBO-BV

Artikel / Article	Beschreibung / Description	Best.-Nr. / Order-Number
Stützbeinsicherung Support leg protection	 Stützbeinsicherung Bolzen DM 30 mm Support leg protection bolt DM 30mm	20350001
Keilriemen V-belt	 Keilriemen GXV 340 Bedarf 2 St. V-belt GXV 340 req. 2 pc.	21100008
Keilriemen V-belt	 Keilriemen GXV 270 Bedarf 2 St. V-belt GXV 270 req. 2 pc.	21100002
Filter	 Luftfilter Patrone GXV 340 Air filter cartridge GXV 340	25000046
Filter	 Kraftstofffilter GXV 340 Fuel filter GXV 340	26900001
Filter	 Luftfilter für GXV 270 Air filter for GXV 270	25000020
Luftfilter Deckel Air filter Cover	 Gehäusedeckel housing cover	25050013
Filter Vakuum Filter vacuum	 Luftfilter Vakuum Air filter vacuum	42100085
Zündkerze Spark plug	 Zündkerze für GXV 270/340 Spark plug for GXV 270/340	26910007
Batterie Battery	 12 V Batterie 12 V Battery	24200008
BV-Zuführschlauch Klapp Ausleger BV feed hose Folding boom	 Vakuum-Zuführschlauch aus Polyurethan, 60 mm, 2,0 m Vacuum feed hose in polyurethane, 60 mm, 2.0 m	42200017

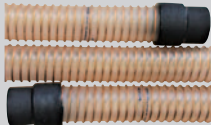

Vakuum-Bordsteinverlegegerät / Vacuum Kerb Stone Installation Machine JUMBO-BV

Artikel / Article	Beschreibung / Description	Best.-Nr. / Order-Number
BV-Zuführschlauch Klapp Ausleger BV feed hose Folding boom 	Vakuum-Zuführschlauch aus Polyurethan, 60 mm, 1,5 m mittlerer Schlauch Vacuum feed hose in polyurethane, 60 mm, 1.5 m, middle hose	42200019
BV-Zuführschlauch Klapp Ausleger/vario BV feed hose Folding boom/vario 	Vakuum-Zuführschlauch aus Polyurethan, 60 mm, 3,5 m mit Endmuffen Vacuum feed hose in polyurethane, 60 mm, 3.5 m with end sleeves	42200434
BV-Fahrwagen BV carriage 	Fahrwagen kompl. für Hubeinheit HE Carriage compl. for HE lift unit	42200042 -002
BV-Vario/Klapp-Ausleger BV-Vario/folding boom 	Zuführschlauch 1,00 m, 60 mm feed hose 1.00 m, 60mm	42200034
Feder Spring 	Paßfeder Feather key	21750002
Drahtschelle Wire clip 	für Schlauch for hose	21050017



Vakuum-Bordstein-Verlegelader / Vacuum Kerb Stone Laying Loader UNIPOSE UP-604/UP-1204

Artikel / Article	Beschreibung / Description	Best.-Nr. / Order-Number
Motorölfiltereinsatz Motor Oil Filter 	für UNIPOSE UP-1204/UNIPOSE UP-604 for UNIPOSE UP-1204/UNIPOSE UP-604	26110094
Kraftstofffiltereinsatz Fuel Filter 	für UNIPOSE UP-1204/UNIPOSE UP-604 for UNIPOSE UP-1204/UNIPOSE UP-604	26900032
Kraftstoffvorfilter Fuel Filter 	für UNIPOSE UP-604 for UNIPOSE UP-604	26900033
Luftfiltereinsatz klein Motor Air Filter Insert 	für UNIPOSE UP-1204 for UNIPOSE UP-1204	25000064
Luftfiltereinsatz Motor Air Filter Insert Engine 	für UNIPOSE UP-1204/UNIPOSE UP-604 for UNIPOSE UP-1204/UNIPOSE UP-604	25000050
HD-Ölfilter HD-Oil Filter 	für UNIPOSE UP-1204/UNIPOSE UP-604 for UNIPOSE UP-1204/UNIPOSE UP-604	26990070
Luftfilter Vakuumgebläse Air Filter Vacuum 	für UNIPOSE UP-1204/UNIPOSE UP-604 for UNIPOSE UP-1204/UNIPOSE UP-604	25000036



MULTIMOBIL MM

Artikel / Article	Beschreibung / Description	Best.-Nr. / Order-Number
Luftfilter Air filter	Luftfilter zu MM-Diesel Air filter for MM-Diesel	25000087
Ölfiter Oil filter	Ölfiter zu MM-Diesel Oil filter for MM-Diesel	26110124
HD-Ölfiter HD-Oilfilter	HD-Ölfiter zu MM-Diesel / MM-GREENLINE HD-Oilfilter for MM-Diesel / MM-GREENLINE	26110123
Gleitlager Plain bearing	Gleitlager Bronze-Buchse Di 65,3 x Da 74,9r7 x 60 kg Plain bearing Di 65,3 x Da 74,9r7 x 60 kg	21400055
DK Rundbuchse Bushing with flange	DK Rundbuchse Di 25 x Da 28 x 21,5 kg Bushing with flange Di 25 x Da 28 x 21,5 kg	21400030

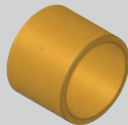





JUMBOMOBIL JM-VARIO

Artikel / Article	Beschreibung / Description	Best.-Nr. / Order-Number
Luftfilter Air filter 	Luftfilter Micro-Top-C-15-300 Air filter Micro-Top-C-15-300	42100085
Vakuump Schlauch Vacuum hose 	Vakuump Schlauch, Ø 60 mm (Meterware) Vacuum hose Ø 60 mm (by metre)	25200008
Vakuump Schlauch Vacuum hose 	Vakuump Schlauch Ø 60 mm 7 m lang inkl Kupplungen Vacuum hose Ø 60 mm 7 m long coupling included	42100030
Vakuump Schlauch Vacuum hose 	Vakuump Schlauch 60x1000 mm mit Endmuffen Vacuum hose 60x1000 mm end sleeves included	42200034
Keilriemen V-belt 	Keilriemen 10x865 (GXV340) V-belt 10x865 (GXV340)	21100008
Kraftstofffilter Fuel filter 	Kraftstofffilter für GXV340 Fuel filter for GXV340	26900001
Zündkerze Spark plug 	Zündkerze BPR5 Spark plug BPR5	26910007
Luftfilter Air filter 	Luftfilter für GXV340 Air filter for GXV340	25000046
Vakuump Schlauch Vacuum hose 	Vakuump Schlauch 483 mm 2x90° Bogen Vacuum hose 483 mm 2x90° end	42200277
Vakuump Schlauch Vacuum hose 	Vakuump Schlauch 260 mm 1x90° Bogen Vacuum hose 260 mm 1x90° end	42200055
Bowdenzug Bowden cable 	Bowdenzug mit Regulierhebel Accelerator bowden cable with regulating lever	21000199







JUMBOMOBIL JM-VARIO

Artikel / Article	Beschreibung / Description	Best.-Nr. / Order-Number
Akku	 Akku 12 V / 26 Ah	24200008
Startergriff Starter handle	 Startergriff 750 mm Starter handle 750 mm	21600025
Bolzen Bolt	 Bolzen mit Handgriff 20 mm Bolt with handle 20 mm	20390001









Verlegetransporter / Installation Carrier TRANSMOBIL TM-150-B-(XL)

Artikel / Article	Beschreibung / Description	Best.-Nr. / Order-Number
Wartungskit klein für TM-150-B Service kit small for TM-150-B	Bestehend aus: Luftfilter, Luftfilter Vakuum, Zündkerze Consists of: Air Filter, Air Filter vacuum, spark plug	42220220
Wartungskit groß für TM-150-B Service kit large for TM-150-B	Bestehend aus: Wartungskit klein + HD Öl Filter, O-Ring, Keilriemen Consists of: Service kit small + HD Oil Filter, O-ring, V-Belt	42220221
TM-Zuführschlauch TM feed hose	 Vakuum-Zuführschlauch aus Polyurethan, 60 mm, 2,35 m Vacuum feed hose in polyurethane, 60 mm, 2.35 m	42200101
TM-Zuführschlauch TM feed hose	 Vakuum-Zuführschlauch aus Polyurethan, 60 mm, 2,0 m Vacuum feed hose in polyurethane, 60 mm, 2.0 m	42200017
TM-Fahrgewagen TM carriage	 Fahrgewagen kompl. für Hubeinheit HE Carriage compl. for HE lift unit	42200042 -002
Antriebsmotor Gebläse Drive motor fan	 Axialkolbenpumpe Axial piston pump	22600005









Verlegetransporter / Installation Carrier TRANSMOBIL TM-150-D

Artikel / Article	Beschreibung / Description	Best.-Nr. / Order-Number
Wartungskit klein für TM-150-D Versionen Small maintenance kit for TM-150-D versions 	Wartungskit bestehend aus: Luftfilter, Motorölfilter, Kraftstofffilter, O-Ring für Ölfilter, Vakuum-Luftfilter Maintenance kit includes: air filter, motor oil filter, fuel filter, O-ring for oil filter, Vacuum air filter	42220208
Wartungskit groß für TM-150-D Versionen Large maintenance kit for TM-150-D versions 	Wartungskit bestehend aus: Wartungskit klein, Hydraulikölfilter, Ventildeckeldichtung, O-Ring-Ölmeßstab, O-Ring HD-Filtergehäuse, Keilriemen (2 Stück) Maintenance kit includes: small maintenance kit, hydraulic oil filter, valve cover seal, O-ring oil dipstick, O-Ring HD filter housing, V-belt (x2)	42220209
Gaszug Accelerator cable 	Bowdenzug mit Bedienteil Bowden cable with operating unit	21000376
TM-Zuführschlauch TM feed hose 	Vakuum-Zuführschlauch aus Polyurethan, 60 mm, 2,35 m Vacuum feed hose in polyurethane, 60 mm, 2.35 m	42200101
TM-Zuführschlauch TM feed hose 	Vakuum-Zuführschlauch aus Polyurethan, 60 mm, 2,0 m Vacuum feed hose in polyurethane, 60 mm, 2.0 m	42200017
TM-Fahrwagen TM carriage 	Fahrwagen kompl. für Hubeinheit HE Carriage compl. for HE lift unit	42200042-002
Antriebsmotor Gebläse Drive motor fan 	Axialkolbenpumpe Axial piston pump	22600005

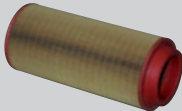

Verlegetransporter / Installation Carrier TRANSMOBIL TM-150-WD-A-SILENT-XL

Artikel / Article	Beschreibung / Description	Best.-Nr. / Order-Number
Filter 	Hydraulikölfilter Hydraulic oil filter	26110102
Filter 	Motorölfilter Engine oil filter	26900019
Filter 	Kraftstofffilter Fuel filter	26900006
Filter 	Vakuum Luftfilter Vacuum air filter	42100085
Keilriemen V-belt 	Keilriemen V-belt	21100001
TM-Zuführschlauch TM feed hose 	Vakuum-Zuführschlauch aus Polyurethan, 60 mm, 2,35 m Vacuum feed hose in polyurethane, 60 mm, 2.35 m	42200101
TM-Zuführschlauch TM feed hose 	Vakuum-Zuführschlauch aus Polyurethan, 60 mm, 2,0 m Vacuum feed hose in polyurethane, 60 mm, 2.0 m	42200017
TM-Fahrwagen TM carriage 	Fahrwagen kompl. für Hubeinheit HE Carriage compl. for HE lift unit	42200042-002
Antriebsmotor Gebläse Drive motor fan 	Axialkolbenpumpe Axial piston pump	22600005



Vakuum-Schlauchheber-Komponenten / Vacuum Hose Lifter Components HE-35

Artikel / Article	Beschreibung / Description	Best.-Nr. / Order-Number
Ersatzhubschlauch Replacement lift hose 	für HE-35 2,5 m lang for HE-35 2.5 m long, \varnothing 120 mm	25270008
Bandkorsett Tape corset 	für Hubschlauch HE-35, \varnothing 120 mm for HE-35 lift hose, \varnothing 120 mm	25270016
Schutzhülle Protective cover 	für Vakuumschlauch HE-35 for HE-35 vacuum hose	25290042
Dichtband Sealing tape 	für Hubschlauch for Lift hose	42100090
O-Ring 	O-Ring für Anschlußkupplung O-ring for connection	21550143
Karabiner Snap 	Karabiner Snap hook	21020012



Vakuum-Schlauchheber-Komponenten / Vacuum Hose Lifter Components HE-50

Artikel / Article	Beschreibung / Description	Best.-Nr. / Order-Number
Ersatzhubschlauch Replacement lift hose	 für HE-50 2,5 m lang, \varnothing 140 mm for HE-50 2.5 m long, \varnothing 140 mm	25270003
Schutzhülle Protective cover	 für Vakuumschlauch HE-50 for HE-50 vacuum hose	25290006
Bandkorsett Tape corset	 für Hubschlauch HE-50 for HE-50 lift hose	25270017
Dichtband Sealing tape	 für Hubschlauch for Lift hose	42100090
O-Ring	 O-Ring für Anschlusskupplung O-ring for connection	21550143
Karabiner Snap	 Karabiner Snap hook	21020012



Vakuum-Schlauchheber-Komponenten / Vacuum Hose Lifter Components HE-85

Artikel / Article	Beschreibung / Description	Best.-Nr. / Order-Number
Ersatzhubschlauch Replacement lift hose 	für HE-85 2,5 m lang, \varnothing 178 mm for HE-85 2.5 m long, \varnothing 178 mm	25270002
Schutzhülle Protective cover 	für Vakuumschlauch HE-85 for HE-85 vacuum hose	25290004
Bandkorsett Tape corset 	für Hubschlauch HE-85 for HE-85 lift hose	25270018
Dichtband Sealing tape 	für Hubschlauch for Lift hose	42100090
O-Ring 	O-Ring für Anschlusskupplung O-ring for connection	21550143
Karabiner Snap 	Karabiner Snap hook	21020012



Vakuum-Schlauchheber-Komponenten / Vacuum Hose Lifter Components HE-150

Artikel / Article	Beschreibung / Description	Best.-Nr. / Order-Number
Ersatzhubschlauch Replacement lift hose	 für HE-150 2,5 m lang, Ø 230 mm for HE-150 2.5 m long, Ø 230 mm	25270010
Schutzhülle Protective cover	 für Vakuumschlauch HE-150 for HE-150 vacuum hose	25290007
Bandkorsett Tape corset	 für Hubschlauch HE-150 for HE-150 lift hose	25270005
Bandkorsett verstärkt Reinforced tape corset	 für HE-150 verstärkte Version for HE-150 reinforced version	25270035
Dichtband Sealing tape	 für Hubschlauch for Lift hose	42100090
Schlauchschelle Hose clip	 Gelenkbolzen Schlauchschelle Spannweite 240 – 252 mm Hose clip link pin span 240 – 252 mm	21050068
O-Ring	 O-Ring für Anschlusskupplung O-ring for connection	21550143
Karabiner Snap	 Karabiner Snap hook	21020012



Vakuum-Schlauchheber-Komponenten / Vacuum Hose Lifter Components HE-200

Artikel / Article	Beschreibung / Description	Best.-Nr. / Order-Number
Ersatzhubschlauch Replacement lift hose 	für HE-200 2,5 m lang, Ø 250 mm for HE-200 2.5 m long, Ø 250 mm	25270007
Schutzhülle Protective cover 	für Vakuumschlauch HE-200 for HE-200 vacuum hose	25290024
Bandkorsett Tape corset 	für Hubschlauch HE-200 for HE-200 lift hose	25270009
Dichtband Sealing tape 	für Hubschlauch for Lift hose	42100090
Schlauchschelle Hose clip 	Gelenkbolzen Schlauchschelle Spannweite 240 – 252 mm Hose clip link pin span 240 – 252 mm	21050068
O-Ring 	O-Ring für Anschlusskupplung O-ring for connection	21550143
Karabiner Snap 	Karabiner Snap hook	21020012











Vakuum-Schlauchheber-Komponenten / Vacuum Hose Lifter Components HE-250

Artikel / Article	Beschreibung / Description	Best.-Nr. / Order-Number
Ersatzhubschlauch Replacement lift hose 	für HE-250 2,5 m lang, Ø 300 mm for HE-250 2.5 m long, Ø 300 mm	25270015
Schutzhülle Protective cover	für Vakuumschlauch HE-250 for HE-250 vacuum hose	25290039
Bandkorsett Tape corset 	für Hubschlauch HE-250 for HE-250 lift hose	25270021
Dichtband Sealing tape 	für Hubschlauch for Lift hose	42100090
O-Ring 	O-Ring für Anschlusskupplung O-ring for connection	21550143
Karabiner Snap 	Karabiner Snap hook	21020012

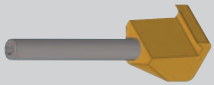



Bedieneinheit / Operating Valve Unit BE-SPRINT-2

Artikel / Article	Beschreibung / Description	Best.-Nr. / Order-Number
Filtermatte Filter mat	 für BE for BE	25050010
Ventilklappe Valve flap	 mit Halterung für BE with mounting for BE	42100558
Zugfeder Tension spring	 0,7 x 7,5 x 38 für BE 0.7 x 7.5 x 38 for BE	21710008
Zugfeder Tension spring	 0,9 x 10 x 36 für BE 0.9 x 10 x 36 for BE	21710009
Manometer	 Vakuumanometer Vacuum manometer	22130007
Spannhaken Tension hook	 für Spannverschluss an BE for tension lock on BE	21060011
Spannverschluß Tension lock		21060004
Spannhaken Tension hook	 verstärkt reinforced	42100952
Schlitzgummi Slotted rubber	 für Ventileinheit for valve unit	42100091
Reibbelag Friction lining	 weiss white	42100613
Steuerscheibe Control washer	 Edelstahl Stainless steel	42100614



Bedieneinheit / Operating Valve Unit BE-SPRINT-2

Artikel / Article	Beschreibung / Description	Best.-Nr. / Order-Number
Abdeckung Cover 	für Ventilgehäuse for valve casing	42100488
Rändelschraube Knurled screw 	für Ventilgehäuse for valve casing	20090038
Ventilgehäuse Valve Housing 	Ventilgehäuse komplett Valve Housing complete	42100612







Ersatzdichtungen zu Saugplatten / Replacement Seals for Suction Plates SH/VPM/PJ

Artikel / Article	Beschreibung / Description	Best.-Nr. / Order-Number
SH/VPM/PJ Dichtring SH/VPM/PJ sealing ring	Ersatzdichtung für SPS-200 (Dichtring Nr. 1248) Replacement sealing ring for SPS-200 (no. 1248)	42700009
SH/VPM/PJ Dichtring SH/VPM/PJ sealing ring	Ersatzdichtung für SPS-500 und 400 (Dichtring Nr. 1068) Replacement sealing ring for SPS-500 and 400 (no. 1068)	42500002
SH/VPM/PJ Dichtring SH/VPM/PJ sealing ring	Ersatzdichtung für SPS-1000 (Dichtring Nr. 1033) Replacement sealing ring for SPS-1000 (no. 1033)	42500001
SH/VPM/PJ Dichtring SH/VPM/PJ sealing ring	Ersatzdichtung für SPS-1010 (Dichtring Nr. 1072) Replacement sealing ring for SPS-1010 (no. 1072)	42500006
SH/VPM/PJ Dichtring SH/VPM/PJ sealing ring	Ersatzdichtung für SPS-1200 (Dichtring Nr. 1070) Replacement sealing ring for SPS-1200 (no. 1070)	42500005
SH/VPM/PJ Dichtring SH/VPM/PJ sealing ring	Ersatzdichtung für SPS-1500 (Dichtring Nr. 1090) Replacement sealing ring for SPS-1500 (no. 1090)	42500004
SH/VPM/PJ Dichtring SH/VPM/PJ sealing ring	Ersatzdichtung für SPS-2500 (Dichtring Nr. 1499) Replacement sealing ring for SPS-2500 (no. 1499)	42500111
SH/VPM/PJ Dichtring SH/VPM/PJ sealing ring	Ersatzdichtung für SPS-3500 (Dichtring Nr. 5001) Replacement sealing ring for SPS-3500 (no. 5001)	42500154



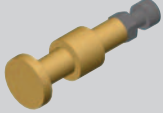

Einfach-Saugplatten ESP – alle Arten / Suction Plates ESP – all types

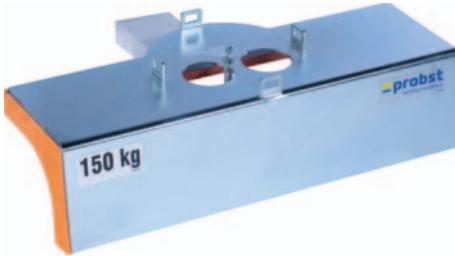
Artikel / Article	Beschreibung / Description	Best.-Nr. / Order-Number
Schwammgummi Sponge rubber 	für ESP/WSP (Meterware) for ESP/WSP (by meter)	42100024
Kleber Glue 	für Schwammgummi (Bedarf ca. 1 Dose für 2 lfm) For sponge rubber (requirement approx. 1 can for 2 m)	52100001
Klebeband Adhesive tape 	Doppelseitiges Klebeband 50 m Double-sided adhesive tape 50 m	29050103
Stößel komplett Complete tappet 	Stößel komplett inkl. Anschweißbuchse Complete tappet incl. weld-on bush	42101054
Stößel einfach Simple tappet 	Stößel einfach Simple tappet	21070008



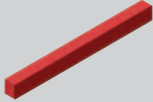

Winkel-Saugplatten / Angeled Suction Plates WSP-150-52/15-12-98°

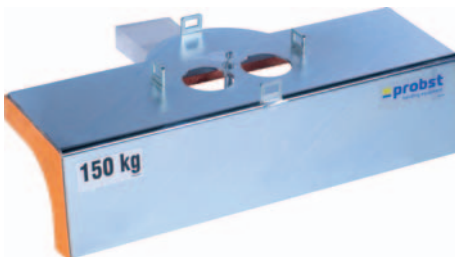
Artikel / Article	Beschreibung / Description	Best.-Nr. / Order-Number
Schwammgummi Sponge rubber	 Seitenteil für WSP Side section for WSP	42100200
Schwammgummi Sponge rubber	 für ESP/WSP (Meterware) for ESP/WSP (by meter)	42100024
Kleber Glue	 für Schwammgummi (Bedarf ca. 1 Dose für 2 lfm) For sponge rubber (requirement approx. 1 can for 2 m)	52100001



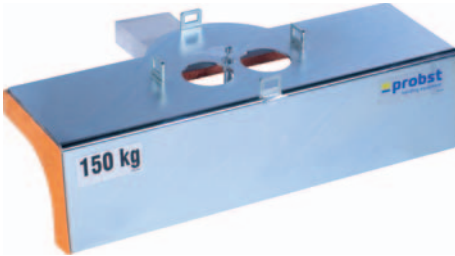

Winkel-Saugplatten / Angeled Suction Plates WSP-150-70/8-11-143° – WSP-150-70/11-17-143° – WSP-150-85/7-7-135° – WSP-150-70/13-10-143°

Artikel / Article	Beschreibung / Description	Best.-Nr. / Order-Number
Schwammgummi Sponge rubber	 für ESP/WSP (Meterware) for ESP/WSP (by meter)	42100024
Kleber Glue	 für Schwammgummi (Bedarf ca. 1 Dose für 2 lfm) For sponge rubber (requirement approx. 1 can for 2 m)	52100001

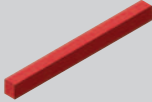

Winkel-Saugplatten / Angeled Suction Plates WSP-150-90/10-14-93°

Artikel / Article	Beschreibung / Description	Best.-Nr. / Order-Number
Schwammgummi Sponge rubber 	Seitenteil für WSP Side section for WSP	42100200
Schwammgummi Sponge rubber 	für ESP/WSP (Meterware) for ESP/WSP (meter)	42100024
Kleber Glue 	für Schwammgummi (Bedarf ca. 1 Dose für 2 lfm) for sponge rubber (requirement approx. 1 can for 2 m)	52100001





Mehrfachsugplatten / Multiple Suction Plates MSP-5-V-150-5 x SPS 24/16-a-24 – MSP-5-V-150-5 x SPS 24/16-a-25 (ab 2015 / from 2015)

Artikel / Article	Beschreibung / Description	Best.-Nr. / Order-Number
Ersatzdichtring Replacement sealing ring 	Dichtring Nr. 1540 Sealing ring no. 1540	42500066
Vakuum-Zuführschlauch Vacuum feed hose 	Meterware By the metre	25200026



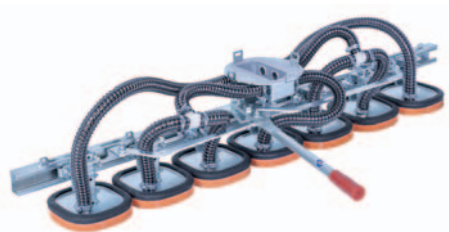

Mehrfachsaugplatten / Multiple Suction Plates MSP-5-V-150-5 x SPS-22/12-a-23,5

Artikel / Article	Beschreibung / Description	Best.-Nr. / Order-Number
Ersatzdichtring Replacement sealing ring 	Dichtring Nr. 1187 Sealing ring no. 1187	42500152
Vakuum-Zuführschlauch Vacuum feed hose 	Meterware By the metre	25200026





Mehrfachsaugplatten / Multiple Suction Plates MSP-7-V-150-7 x SPS-17/16-a-16

Artikel / Article	Beschreibung / Description	Best.-Nr. / Order-Number
Ersatzdichtring Replacement sealing ring 	Dichtring Nr. 1495 Sealing ring no. 1495	42500109
Vakuum-Zuführschlauch Vacuum feed hose 	Meterware By the metre	25200026



Mehrfachsaugplatten / Multiple Suction Plates MSP-7-V-150-7 x SPS-16/14-a-16

Artikel / Article	Beschreibung / Description	Best.-Nr. / Order-Number
Ersatzdichtring Replacement sealing ring	 Dichtring Nr. 1494 Sealing ring no. 1494	42500047
Vakuum-Zuführschlauch Vacuum feed hose	 Meterware By the metre	25200026

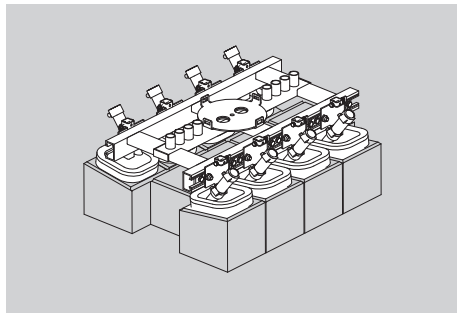

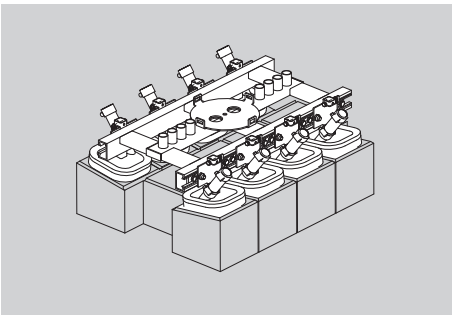

Mehrfachsaugplatten / Multiple Suction Plates MSP-3-S-85-3 x SPS 23/13-a 35-40

Artikel / Article	Beschreibung / Description	Best.-Nr. / Order-Number
Ersatzdichtring Replacement sealing ring	Dichtring Nr. 1187 Sealing ring no. 1187	42500152
Vakuum-Zuführschlauch Vacuum feed hose	 Meterware By the metre	25200026



Mehrfachsaugplatten / Multiple Suction Plates





MSP-8-S-150-8 x SPS 13/15-a 15 –
MSP-8-(2x4)-S-150-8 x SPS 13/15

Artikel / Article	Beschreibung / Description	Best.-Nr. / Order-Number
Ersatzdichtring Replacement sealing ring	 Dichtring Nr. 1491 Sealing ring no. 1491	42500047
Vakuum-Zuführschlauch Vacuum feed hose	 Meterware By the metre	25200026



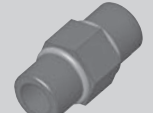

Mehrfachsaugplatten / Multiple Suction Plates

MFS-150-7-S-15Rd + MFS-150-7-V-15Rd

Artikel / Article	Beschreibung / Description	Best.-Nr. / Order-Number
Faltenbalg Suction plate bellows	 Durchmesser 150mm Diameter 150mm	42101494
Doppelnippel Double nipple	 zur Faltenbalgbefestigung Double nipple for suction plate	23200034
Verschlussstopfen Plug	 ½" Closing plug ½"	20590002
Dichtring Seal ring	 zu Verschlussstopfen Seal ring for plug	21590044
Handgriff Handle	 PVC ½" Handle pvc ½"	21600005



Mehrfachsaugplatten / Multiple Suction Plates MFS-150-7-S-15Rd + MFS-150-7-V-15Rd

Artikel / Article	Beschreibung / Description	Best.-Nr. / Order-Number
Vakuumschlauch Vacuum hose	 Meterware Vacuum hose meter	25200026
Schelle Fixation	 Befestigungsschelle für Vakuumschlauch Fixation vacuum hose	21050107

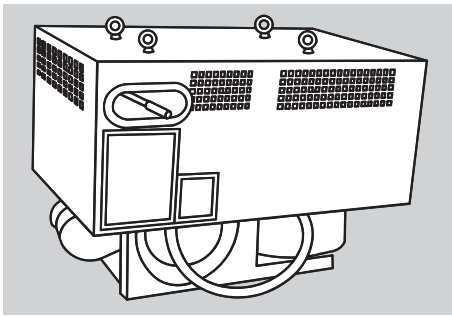





Antrieb über Hydraulik des Trägergerätes – Vakuum Gebläse / Driven by hydraulic energy from Loader – Vacuum Fan VGE-3-RG-H VGE-3-RG-H

Artikel / Article	Beschreibung / Description	Best.-Nr. / Order-Number
Manometer 	Manometer 0-60 bar 0-60 bar manometer	22130023
Manometer 	Manometer 0-250 bar 0-250 bar manometer	22130001
Keilriemen V-belt 	Keilriemen AVX 10 x 865 AVX 10 x 865 V-belt	21100008
Euro Piclon Gehäuse Euro Piclon housing 	Euro-Piclon Gehäuse Unterteil Euro-Piclon housing bottom section	25050013
Luftfilter Patrone Air filter cartridge 	Luftfilter Patrone MicroTop Mann-C-15-300 MicroTop Mann-C-15-300 air filter cartridge	42100085
Luftfilter Air filter 	Euro-Piclon Euro-Piclon	25000008
Vakuum-Zuführschlauch Vacuum feed hose 	Meterware By the metre	25200008

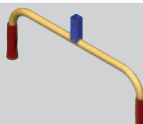

Bordsteinversetzzange / Kerb Stone Clamp VZ-M-UNI

Artikel / Article	Beschreibung / Description	Best.-Nr. / Order-Number
Wechselautomatik Automatic changer 	Einsatz für Wechselautomatik Insert for automatic changer	40110040
Spannstift Spring pin 	für Wechselautomatik, DIN 1481, Dm 8 x 30 for automatic changer, DIN 1481, Dm 8 x 30	20530019
Spannstift Spring pin 	für Wechselautomatik, DIN 1481, Dm 16 x 30 for automatic changer, DIN 1481, Dm 16 x 30	20530038
Handgriff Handle 	Handgriff verzinkt Handle galvanized	43100016
Zugfeder Tension spring 	Zugfeder 1,25 x 10 x 170 1.25 x 10 x 170 tension spring	21710003
GMT Gummischiene, schwarz GMT rubber track, black 	GMT Gummi für VZ-M-UNI 60 x 15 x 150 mm GMT rubber for 60 x 15 x 150mm VZ-M-UNI	36330057







Bordsteinzange / Kerb Stone Handles BZ

Artikel / Article	Beschreibung / Description	Best.-Nr. / Order-Number
BZ-Gummi, grau BZ rubber, grey 	Gummi für BZ Rubber for BZ	43200006
Befestigungsschrauben Fixing screws 	Schrauben Bedarf 2 Stück pro Gummi Screws needed 2x per rubber	20030009
Handgriff Handle 	Kunststoff-Handgriff rot Plastic handle red	21600016

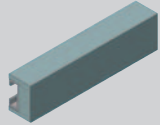

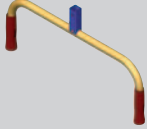



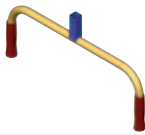

Bordsteinversetzzange / Universal Handle BVZ

Artikel / Article	Beschreibung / Description	Best.-Nr. / Order-Number
BVZ-Gummi schwarz BVZ rubber, black 	Gummi BVZ 50 x 35 x 200 mm 50 x 35 x 200 mm BVZ rubber	36710200
BVZ-Gummi grau BVZ rubber, grey 	Gummi BVZ 50 x 35 x 200 mm 50 x 35 x 200 mm BVZ rubber	36760200
Bolzen Bolt 	Bolzen mit Halbring Bolt with half ring	30320001
Handgriff Handle 	Handgriff verzinkt Handle galvanized	43100016
Handgriff Handle 	Kunststoff-Handgriff rot Plastic handle red	21600016







Versetzzange / Laying Clamp VZ

Artikel / Article	Beschreibung / Description	Best.-Nr. / Order-Number
Handgriff Handle	 Handgriff verzinkt (VZ-I / VZ-II) Handle galvanized (VZ-I / VZ-II)	43100016
Handgriff Handle	 Kunststoff-Handgriff rot (VZ-I / VZ-II) Plastic handle red (VZ-I / VZ-II)	21600016
Bolzen Bolt	 Bolzen mit Halbring (VZ-I) Bolt with half ring (VZ-I)	30320001
Gummischiene, schwarz Rubber track, black	 GMT (VZ-II) 60 x 15 x 100 mm	36330160
Gummischiene, schwarz Rubber track, black	 GMT (VZ-II) 60 x 15 x 200 mm	36330040
Gummischiene, schwarz Rubber track, black	 GMT (VZ-III) 60 x 15 x 420 mm	36330050
Handgriff Handle	 Rohrklappsplint 8 mm (VZ-I / VZ-II) Pipe lynchpin 8 mm (VZ-I / VZ-II)	20540040

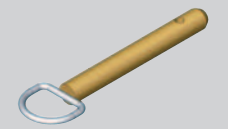

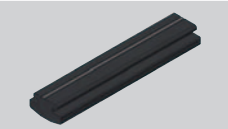





Rabattengreifer / Border Stone Handle EASYGRIP EXG/EXG-MAXI

Artikel / Article	Beschreibung / Description	Best.-Nr. / Order-Number
Bolzen Bolt 	Bolzen mit Halbring, Ø 20 mm, Länge 44 mm Bolt with half ring, Ø 20 mm, length 44 mm	30320150
Bolzen Bolt 	Bolzen mit Halbring, Ø 16 mm, Länge 126 mm Bolt with half ring, Ø 16 mm, length 126 mm	30320152
Klappsplint Clip pin 	Klappsplint 6 mm 6 mm clip pin	20540002
Profil-Gummi-Leiste, schwarz Rubber strip profile, black 	PGL3/R62 235 mm lang PGL3/R62 235 mm long	36370048
Profil-Gummi-Leiste, grau Rubber strip profile, grey 	PGL3/ 235 mm lang PGL3/ 235 mm long	36370051
Handgriff Handle 	PVC-Handgriff rot ¾" PVC-handle red ¾"	21600016



Rand- und Leistensteinheber / Kerb and Strip Stone handle TWISTGRIP TG-5/12

Artikel / Article	Beschreibung / Description	Best.-Nr. / Order-Number
Gummischiene grau Rubber track grey	 Gummischiene grau, 60 x 15 x 90 Rubber track grey, 60 x 15 x 90	36330309
Befestigung Gummischiene Rubber rail fixing	 Senkschraube M 6 x 12 Countersunk screw M 6 x 12	20040043
Befestigung Backe Gripper fixing	 Flügelschraube M 8 x 110 Wing screw M 8 x 110	43200106
Befestigung Backe Gripper fixing	 Flügelmutter Wing nut	20160003
Handgriff Handle	 Holzhandgriff Wooden handle	21600051
Befestigung Handgriff Handle fixing	 Sechskantschraube M 8 x 150 Hex screw M 8 x 150	20000360
Befestigung Handgriff Handle fixing	 Sechskantmutter M 8 Hex nut M 8	20100015

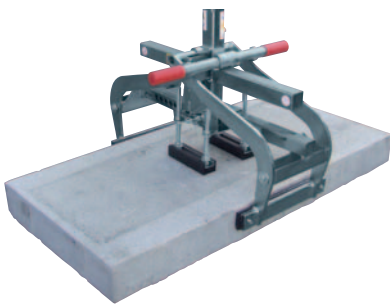

Trittstufenversetzungen / Concrete Step Handles TSZ-UNI/TSZ-MAXI

Artikel / Article	Beschreibung / Description	Best.-Nr. / Order-Number
Wechselautomatik Automatic changer 	Einsatz für Wechselautomatik Insert for automatic changer	40110040
Spannstift Spring pin 	für Wechselautomatik, DIN 1481, Dm 8 x 30 for automatic changer, DIN 1481, Dm 8 x 30	20530019
Spannstift Spring pin 	für Wechselautomatik, DIN 1481, Dm 16 x 30 for automatic changer, DIN 1481, Dm 16 x 30	20530038
Federriegel Spring lock 	Federriegel SG 15/14 SG 15/14 spring lock	20540033
Profil-Gummi-Leiste, schwarz Rubber strip profile, black 	PGL 350 mm lang, für TSZ-UNI und -MAXI Art.-Nr. 53100338 und 53100364 PGL 350 mm long, for TSZ-UNI and -MAXI Art.-Nr. 53100338 and 53100364	36370019
Profil-Gummi-Leiste, grau Rubber strip profile, grey 	PGL 350 mm lang, für TSZ-UNI und -MAXI Art.-Nr. 53100338 und 53100364 PGL 350 mm long, for TSZ-UNI and -MAXI Art.-Nr. 53100338 and 53100364	36370030
GMT Gummischiene, schwarz GMT Rubber track, black 	50 x 35 x 350, mit 4 M 8 Gewinde für alte TSZ-Ausführung Art.-Nr. 53100224 50 x 35 x 350, with 4 M 8 thread for old TSZ design item no. 53100224	36320015
GMT Gummischiene, grau GMT Rubber track, grey 	50 x 35 x 350, mit 4 M 8 Gewinde für alte TSZ-Ausführung Art.-Nr. 53100224 50 x 35 x 350, with 4 M 8 thread for old TSZ design item no. 53100224	36320138
GMT Gummischiene, schwarz GMT Rubber track, black 	50 x 35 x 350, mit C-Profil, für alte TSZ-Ausführung Art.-Nr. 53100251 50 x 35 x 350, with C-Profil, for old TSZ design item no. 53100251	36710350
GMT Gummischiene, grau GMT Rubber track, grey 	50 x 35 x 350, mit C-Profil, für alte TSZ-Ausführung Art.-Nr. 53100251 50 x 35 x 350, with C-Profil, for old TSZ design item no. 53100251	36760350
Handgriff Handle 	Handgriff rot Handle red	21600002



Trittstufenversetzzange / Concrete Step Handles TSV

Artikel / Article	Beschreibung / Description	Best.-Nr. / Order-Number
Bolzen Bolt 	Bolzen mit Halbring Bolt with half ring	30320060
Distanzbuchse Spacer bush 	Distanzbuchse 20 x 4 x 9 20 x 4 x 9 spacer bush	33100001
Flügelschraube Wing screw 	Flügelschraube GT GT wing screw	20060005
Flügelmutter Wing nut 	Flügelmutter GT GT wing nut	20160005
Klappsplint Clip pin 	Klappsplint 4,5 mm 4.5 mm clip pin	20540001
Gummischiene, schwarz Rubber track, black 	GMT 60 x 15 x 200 mm	36330040
Gummischiene, grau Rubber track, grey 	GMT 60 x 15 x 200 mm	36330110
Wechsellautomatik Automatic changer 	Einsatz für Wechsellautomatik (ab 09/2021) Insert for automatic changer	40110303







Fertigteilezange / Grab for Prefabricated Concrete Products FTZ-I

Artikel / Article	Beschreibung / Description	Best.-Nr. / Order-Number
Gummischiene, schwarz Rubber track, black	 GMT 60 (50) x 35 x 420 C-Profil GMT 60 (50) x 35 x 420 C-profile	36730420
Gummischiene, grau Rubber track, grey	 GMT 60 (50) x 35 x 420 C-Profil GMT 60 (50) x 35 x 420 C-profile	36760420
Gummischiene, schwarz Rubber track, black	 GMT 60 (50) x 35 x 420 mit 5 Gewinde M 8 GMT 60 (50) x 35 x 420 With 5x M 8 threads	36330005
Gummischiene, grau Rubber track, grey	 GMT 60 (50) x 35 x 420 mit 5 Gewinde M 8 GMT 60 (50) x 35 x 420 With 5x M 8 threads	36320169
Federriegel Spring lock	 Federriegel S22 S22 spring lock	20540022
Kettenschloss Chain lock	 Kettenschloss mit Splintverschluss Bedarf 4 St. Chain lock with split pin fastening req. 4 pc.	21000226
Rollenkette Roller chain	 Einfache Rollenkette Bedarf 2 St. Simple roller chain req. 2 pc.	21000152
Wechselautomatik Automatic changer	 Einsatz für Wechselautomatik Insert for automatic changer	40110040
Spannstift Spring pin	 für Wechselautomatik, DIN 1481, Dm 8 x 30 for automatic changer, DIN 1481, Dm 8 x 30	20530019
Spannstift Spring pin	 für Wechselautomatik, DIN 1481, Dm 16 x 30 for automatic changer, DIN 1481, Dm 16 x 30	20530038
Handgriff Handle	 Handgriff rot Handle red	21600002



Fertigteilzange / Grab for Prefabricated Concrete Products FTZ-BB

Artikel / Article	Beschreibung / Description	Best.-Nr. / Order-Number
Federriegel Spring lock	 Federriegel S22 S22 spring lock	20540022
Kettenschloss Chain lock	 Kettenschloss mit Splintverschluss Bedarf 4 St. Chain lock with split pin fastening req. 4 pc.	21000226
Rollenkette Roller chain	 Einfache Rollenkette Bedarf 2 St. Simple roller chain req. 2 pc.	21000265
Gummischiene, schwarz Rubber track, black	 GMT 60 x 35 x 420 mm	36730420
Gummischiene, grau Rubber track, grey	 GMT 50 x 35 x 420 mm	36760420
Wechselautomatik Automatic changer	 Einsatz für Wechselautomatik Insert for automatic changer	40110040
Spannstift Spring pin	 für Wechselautomatik, DIN 1481, Dm 8 x 30 for automatic changer, DIN 1481, Dm 8 x 30	20530019
Spannstift Spring pin	 für Wechselautomatik, DIN 1481, Dm 16 x 30 for automatic changer, DIN 1481, Dm 16 x 30	20530038
Handgriff Handle	 Handgriff rot Handle red	21600002

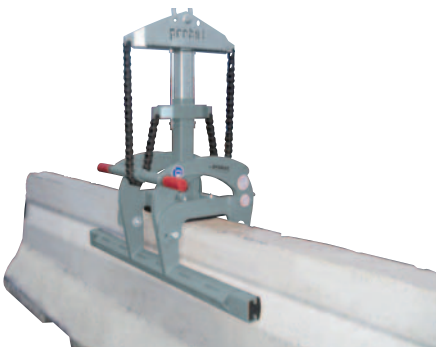

Fertigteilstange / Grab for Prefabricated Concrete Products FTZ-GBA

Artikel / Article	Beschreibung / Description	Best.-Nr. / Order-Number
Wechselautomatik Automatic changer 	Einsatz für Wechselautomatik Insert for automatic changer	40110040
Spannstift Spring pin 	für Wechselautomatik, DIN 1481, Dm 8 x 30 for automatic changer, DIN 1481, Dm 8 x 30	20530019
Spannstift Spring pin 	für Wechselautomatik, DIN 1481, Dm 16 x 30 for automatic changer, DIN 1481, Dm 16 x 30	20530038
Rollenkette Roller chain 	Einfache Rollenkette Bedarf 2 St. Simple roller chain req. 2 pc.	21000134
Kettenschloss Chain lock 	Kettenschloss mit Splintverschluss Bedarf 4 St. Chain lock with split pin fastening req. 4 pc.	21000226
Profil-Gummi-Leiste, schwarz Rubber strip profile, black 	PGL2/R62 1200 mm lang PGL2/R62 1200 mm long	36370018
Handgriff Handle 	Handgriff rot Handle red	21600002
Kette Chain 	Kette oben Chain top	21000244



Fertigteilzange / Grab for Prefabricated Concrete Products FTZ-UNI-15

Artikel / Article	Beschreibung / Description	Best.-Nr. / Order-Number
Wechselautomatik Automatic changer 	Einsatz für Wechselautomatik Insert for automatic changer	40110040
Spannstift Spring pin 	für Wechselautomatik, DIN 1481, Dm 8 x 30 for automatic changer, DIN 1481, Dm 8 x 30	20530019
Spannstift Spring pin 	für Wechselautomatik, DIN 1481, Dm 16 x 30 for automatic changer, DIN 1481, Dm 16 x 30	20530038
Federriegel Spring lock 	Federriegel S22 S22 spring lock	20540022
Rollenkette Roller chain 	Einfache Rollenkette Bedarf 2 St. Simple roller chain req. 2 pc.	21000166
Kettenschloss Chain lock 	Kettenschloss mit Splintverschluss Bedarf 4 St. Chain lock with split pin fastening req. 4 pc.	21000226
Profil-Gummi-Leiste, schwarz Rubber strip profile, black 	PGL 420 mm lang PGL 420 mm long	36370001
Profil-Gummi-Leiste, grau Rubber strip profile, grey 	PGL 420 mm lang PGL 420 mm long	36370007
Handgriff Handle 	Handgriff rot Handle red	21600002



Fertigteilizange / Grab for Prefabricated Concrete Products FTZ-UNI-25 / FTZ-MAXI-25

Artikel / Article	Beschreibung / Description	Best.-Nr. / Order-Number
Wechselautomatik Automatic changer 	Einsatz für Wechselautomatik Insert for automatic changer	40110040
Spannstift Spring pin 	für Wechselautomatik, DIN 1481, Dm 8 x 30 for automatic changer, DIN 1481, Dm 8 x 30	20530019
Spannstift Spring pin 	für Wechselautomatik, DIN 1481, Dm 16 x 30 for automatic changer, DIN 1481, Dm 16 x 30	20530038
Rollenkette FTZ-UNI-25 Roller chain FTZ-UNI-25 	Einfache Rollenkette Bedarf 2 St. Simple roller chain req. 2 pc.	21000166
Rollenkette FTZ-MAXI-25 Roller chain FTZ-MAXI-25 	Einfache Rollenkette Bedarf 2 St. Simple roller chain req. 2 pc.	21000205
Kettenschloss Chain lock 	Kettenschloss mit Splintverschluss Bedarf 4 St. Chain lock with split pin fastening req. 4 pc.	21000226
Bolzen Bolt 	Bolzen mit Halbring Bolt with half ring	30320129
Klappsplint Clip pin 	Klappsplint 6 mm 6 mm clip pin	20540002
Profil-Gummi-Leiste, schwarz Rubber strip profile, black 	PGL 420 mm lang PGL 420 mm long	36370001
Profil-Gummi-Leiste, grau Rubber strip profile, grey 	PGL 420 mm lang PGL 420 mm long	36370007
Handgriff Handle 	Handgriff rot Handle red	21600002



Fertigteilzange / Grab for Prefabricated Concrete Products FTZ-UNI-50

Artikel / Article	Beschreibung / Description	Best.-Nr. / Order-Number
Wechselautomatik Automatic changer 	Einsatz für Wechselautomatik Insert for automatic changer	40110042
Spannstift Spring pin 	für Wechselautomatik 16 x 50 for automatic changer 16 x 50	20530039
Spannstift Spring pin 	für Wechselautomatik 8 x 50 for automatic changer 8 x 50	20530022
Bolzen Bolt 	Bolzen mit Halbring Bolt with half ring	30320087
Rollenkette Roller chain 	Einfache Rollenkette Simple roller chain	21000225
Klappsplint Clip pin 	Klappsplint verzinkt Clip pin galvanized	20540013
Profil-Gummi-Leiste, schwarz Rubber strip profile, black 	PGL2 720 mm lang PGL2 720 mm long	36370038
Profil-Gummi-Leiste, grau Rubber strip profile, grey 	PGL 720 mm lang PGL2 720 mm long	36370054
Handgriff Handle 	Handgriff rot Handle red	21600016



Fertigteilzange / Grab for Prefabricated Concrete Products FTZ-MAXI-40

Artikel / Article	Beschreibung / Description	Best.-Nr. / Order-Number
Wechselautomatik Automatic changer 	Einsatz für Wechselautomatik Insert for automatic changer	40110042
Spannstift Spring pin 	für Wechselautomatik 16 x 50 for automatic changer 16 x 50	20530039
Spannstift Spring pin 	für Wechselautomatik 8 x 50 for automatic changer 8 x 50	20530022
Bolzen Bolt 	Bolzen mit Halbring Bolt with half ring	30320087
Rollenkette Roller chain 	Einfache Rollenkette Simple roller chain	21000134
Kettenschloss Chain lock 	Kettenschloss mit Splintverschluss Chain lock with split pin fastening	21000226
Klappsplint Clip pin 	Klappsplint verzinkt Clip pin galvanized	20540013
Profil-Gummi-Leiste, schwarz Rubber strip profile, black 	PGL 720 mm lang PGL 720 mm long	36370004
Profil-Gummi-Leiste, grau Rubber strip profile, grey 	PGL 720 mm lang PGL 720 mm long	36370014
Handgriff Handle 	Handgriff rot Handle red	21600016



Fertigteilzange / Grab for Prefabricated Concrete Products FTZ-MAXI-50

Artikel / Article	Beschreibung / Description	Best.-Nr. / Order-Number
Wechselautomatik Automatic changer 	Einsatz für Wechselautomatik Insert for automatic changer	40110042
Spannstift Spring pin 	für Wechselautomatik 16 x 50 for automatic changer 16 x 50	20530039
Spannstift Spring pin 	für Wechselautomatik 8 x 50 for automatic changer 8 x 50	20530022
Rollenkette Roller chain 	Einfache Rollenkette Simple roller chain	21000134
Kettenschloss Chain lock 	Kettenschloss mit Splintverschluss Chain lock with split pin fastening	21000226
Profil-Gummi-Leiste, schwarz Rubber strip profile, black 	PGL 720 mm lang PGL 720 mm long	36370038
Profil-Gummi-Leiste, grau Rubber strip profile, grey 	PGL 720 mm lang PGL 720 mm long	36370054
Handgriff Handle 	Handgriff rot Handle red	21600016



Fertigteilzange / Grab for Prefabricated Concrete Products FTZ-MULTI-15



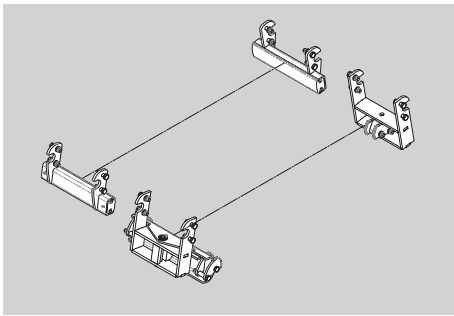

(Grundgerät ohne Greifbacken)

(Basic unit without grippers)

Artikel / Article	Beschreibung / Description	Best.-Nr. / Order-Number
Wechselautomatik Automatic changer 	Einsatz für Wechselautomatik Insert for automatic changer	40110040
Spannstift Spring pin 	für Wechselautomatik, DIN 1481, Dm 8 x 30 for automatic changer, DIN 1481, Dm 8 x 30	20530019
Spannstift Spring pin 	für Wechselautomatik, DIN 1481, Dm 16 x 30 for automatic changer, DIN 1481, Dm 16 x 30	20530038
Federriegel Spring lock 	Federriegel S22 S22 spring lock	20540022
Rollenkette Roller chain 	Einfache Rollenkette Bedarf 2 St. Simple roller chain req. 2 pc.	21000205
Kettenschloss Chain lock 	Kettenschloss mit Splintverschluss Bedarf 4 St. Chain lock with split pin fastening req. 4 pc.	21000226
Handgriff Handle 	Handgriff rot Handle red	21600002

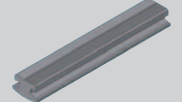

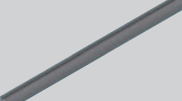

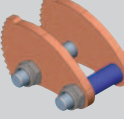

Greifbacken für / Grippers for FTZ-MULTI-15

Artikel / Article	Beschreibung / Description	Best.-Nr. / Order-Number
Profil-Gummi-Leiste, schwarz Rubber strip profile, black 	für FTZ-MULTI-15-WB-G-42, PGL2 420 mm lang for FTZ-MULTI-15-WB-G-42, PGL2 420 mm long	36370031
Profil-Gummi-Leiste, grau Rubber strip profile, grey 	für FTZ-MULTI-15-WB-G-42, PGL2 420 mm lang for FTZ-MULTI-15-WB-G-42, PGL2 420 mm long	36370053
Profil-Gummi-Leiste, schwarz Rubber strip profile, black 	für FTZ-MULTI-15-WB-G-120, PGL2 1200 mm lang for FTZ-MULTI-15-WB-G-120, PGL2 1200 mm long	36370018
Profil-Gummi-Leiste, grau Rubber strip profile, grey 	für FTZ-MULTI-15-WB-G-120, PGL2 1200 mm lang for FTZ-MULTI-15-WB-G-120, PGL2 1200 mm long	36370057
Zahnsegment Gear segment 	für FTZ-MULTI-15-WB-SQ, Zahnsegment für Prätze 3 for FTZ-MULTI-15-WB-SQ, Gear segment for claw 3	33500683
Prätze Claw 	für FTZ-MULTI-15-WB-SQ, vormontiert for FTZ-MULTI-15-WB-SQ, preassembled	44000039

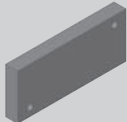

Winkелеlementzange / Grab for Angular Concrete Products WEZ-0.6

Artikel / Article	Beschreibung / Description	Best.-Nr. / Order-Number
Gummischiene Rubber bar	 Gummischiene Grau Rubber bar grey	36370051
Schneidschraube Screw	 zu Gummibefestigung (2x pro Gummi) Screw fixation rubber (2pc required)	20030011
Handgriff Handle	 PVC 3/4" Handle pvc 3/4"	21600016
Auflage Overlay	 Poliamidauflage Polyamide overlay	36410241
Bolzen Bolt	 Bolzen mit Halbring 140 D20 Bolt half ring	30320111
Klappsplint Clip pin	 Klappsplint zu Bolzen Clip pin	20540002





Winkelelementzange / Grab for Angular Concrete Products WEZ-2/WEZ-3/WEZ-6

Artikel / Article	Beschreibung / Description	Best.-Nr. / Order-Number	
Wechselautomatik WEZ-2 Automatic changer WEZ-2	 Einsatz für Wechselautomatik Insert for automatic changer	40110040	
Wechselautomatik WEZ-3 Automatic changer WEZ-3	 Einsatz für Wechselautomatik, 16 mm breit Insert for automatic changer, 16 mm	40110040	
Wechselautomatik WEZ-6 Automatic changer WEZ-6	 Einsatz für Wechselautomatik, 31 mm breit Insert for automatic changer, 31 mm	40110042	
Spannstift WEZ-2 Spring pin WEZ-2		für Wechselautomatik, DIN 1481, Dm 8 x 30 for automatic changer, DIN 1481, Dm 8 x 30	20530019
Spannstift WEZ-6 Spring pin WEZ-6		für Wechselautomatik, DIN 1481, Dm 8 x 50 for automatic changer, DIN 1481, Dm 8 x 50	20530022
Spannstift WEZ-2 Spring pin WEZ-2		für Wechselautomatik, DIN 1481, Dm 16 x 30 for automatic changer, DIN 1481, Dm 16 x 30	20530038
Spannstift WEZ-6 Spring pin WEZ-6		für Wechselautomatik, DIN 1481, Dm 16 x 55 for automatic changer, DIN 1481, Dm 16 x 55	20530040
Klappsplint WEZ-2 Clip pin WEZ-2		Klappsplint 4,5 mm 4.5 mm clip pin	20540036
Klappsplint WEZ-6 Clip pin WEZ-6		Klappsplint 6 mm 6 mm clip pin	20540002
		Klappsplint 8 mm 8 mm clip pin	20540003
Bolzen WEZ-2 Bolt WEZ-2		Bolzen mit Halbring, Ø 20 x 95 mm Bolt with half ring, Ø 20 x 95 mm	30320050
Gummischiene, weiss WEZ-2/WEZ-6 Rubber track, white WEZ-2/WEZ-6		GMT Weiss 110 x 31 x 220 mm GMT white 110 x 31 x 220 mm	36350002
Handgriff WEZ-2/WEZ-6 Handle WEZ-2/WEZ-6		Handgriff rot, 1 Zoll Handle red, 1"	21600002
Auflage PE WEZ-2/WEZ-6 PE layer WEZ-2/WEZ-6		hell, 15 x 55 x 240 mm Light, 15 x 55 x 240 mm	36410154
Auflage PE WEZ-6 PE layer WEZ-6		hell, 90 x 25 x 350 mm Light, 90 x 25 x 350 mm	36410171



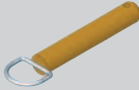



Winkelelementzange / Grab for Angular Concrete Products WEZ-2/WEZ-3/WEZ-6

Artikel / Article	Beschreibung / Description	Best.-Nr. / Order-Number
Bolzen WEZ-6 Bolt WEZ-6 	Bolzen mit Halbring, Ø 25 x 170 mm Bolt with half ring, Ø 25 x 170 mm	30320129
Bolzen WEZ-6 Bolt WEZ-6 	Bolzen mit Halbring, Ø 20 x 172 mm Bolt with half ring, Ø 20 x 172 mm	30320070
Federriegel Spring lock 	Federriegel für WEZ-2 Spring lock for WEZ-2	20540024

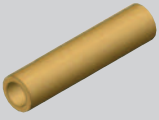

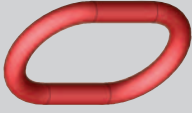





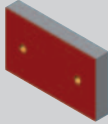

Findling-Versetzzange / Mechanical Boulder Grab FVZ-UNI

Artikel / Article	Beschreibung / Description	Best.-Nr. / Order-Number
Gleitführung Sliding guide 	Gleitführung 90 x 200 Sliding guide 90 x 200	36400204
Hülse Sleeve 	Hülse von Drehpunkt 30 x 5 x 128 Sleeve from pivot 30 x 5 x 128	33507490
Kette Chain 	Kettenstrang mit Haken Chain strand with hook	43100432
Aufhängeglied Suspension link 	Aufhängeglied Form A Suspension link form A	21010018
Handgriff Handle 	Handgriff rot 1/2" Handle red 1/2"	21600005
Handgriff Handle 	Handgriff rot 3/4" Handle red 3/4"	21600016









Stelensetzer / Stone Pillar Grab SLS-8/20-G (-VA)

Artikel / Article	Beschreibung / Description	Best.-Nr. / Order-Number
Gummibacke Rubber jaw	 GB-SLS hell GB-SLS light	36330254
Gummischiene Rubber track	 GMT 60 x 15 x 100 mm	36330215
Handgriff Handle	 Handgriff rot Handle red	21600005
Umbausatz Stahlbacke Retrofit kit steel pads	 Gummigreifbacken zur Nachrüstung von Stelensetzern SLS-10/20 (Best.-Nr. 53100321) mit Stahlbacken, damit werden Verletzungen des Greifgutes durch die Greifbacken vermieden. Greifbereich dann vermindert auf 80 – 180 mm. Rubber grippers to retrofit stone pillar grab SLS-10/20 (Order-Nr. 53100321) equipped as standard with steel pads. Rubber grippers will not cause damages to the stone elements – gripping range is then reduced from 80 to 180 mm.	43101415
Zahnsegment Gear segment	 Zahnsegment aus SLS-10/20 Gear segment from SLS-10/20	33502453
Nutstein Tenon block	 Nutstein für Anschlagverstellung Tenon block	33502249
Schraube Screw	 Schraube für Anschlagverstellung Screw for tenon block	20080002
Scheibe Washer	 Scheibe für Anschlagverstellung Washer for tenon block	20420002
Feder Spring	 Feder für Greifbacke Spring for grippers	21790010



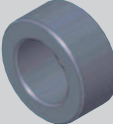

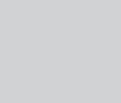
Kabelkanal-Versetzzange / Cable channel KKV-200

Artikel / Article	Beschreibung / Description	Best.-Nr. / Order-Number
Klappsplint Spring pin 	Rohrklappsplint 4,5 mm Spring pin 4,5 mm	20540021
Handgriff Handle 	Kunststoff Handgriff rot 3/4"-Rohr Plastic handle 3/4"	21600016
Wechselautomat Automatic release 	Einsatz für Wechselautomat Insert for automatic release	40110040
Spannstift Locking pin 	Spannstift 8x30 Locking pin 8x30	20530019
Spannstift Locking pin 	Spannstift 16x30 Locking pin 16x30	20530038
Distanzbuchse Bush 	Distanzbuchse 20x4x9 mm Bush 20x4x9 mm	33100001
Sechskantmutter Hex nut 	Sechskantmutter M16x8 Hex nut M16x8	20100018
Sechskantschraube Hex bolt 	Sechskantschraube M12x90 Hex bolt M12x90	20000071







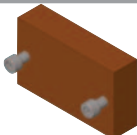

Mechanischer Scherengreifer / Scissor grab SG-80

Artikel / Article	Beschreibung / Description	Best.-Nr. / Order-Number
Gummischiene Rubber track	 Gummischiene C-Profil Greifbacke 1.200 mm lang Rubber track C-Profile Gripping jaw 1,200 mm long	36751200
Handgriff Handle	 Handgriff 3/4" Handle 3/4"	21600016
Gummianschlag Rubber track	 Gummischiene 80 mm lang Rubber track 80 mm long	36750080
Gummischiene Rubber track	 Gummischiene 200 mm lang Rubber track 200 mm long	36710200
Wechselautomat Automatic changer	 Wechselautomat Einsatz Automatic changer insert	40110042
Polyamid-Rad Polyamide wheel	 Polyamid-Rad, 45 mm Nabenbreite Polyamide wheel, 45 mm hub width	21800001
Kette Chain	 Kette für Aufhängung, 31 Glieder Chain for suspension, 31 links	21000245
Schraube Screw	 Sechskantschraube M 8 x 16 für C-Profil Hex screw M 8 x 16 for C profile	20000008
Gewindeplatte Threaded plate	 Gewindeplatte 30 x 24 x 6 Threaded plate 30 x 24 x 6	20190018

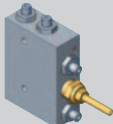

Hydraulische Versetzzange / Hydraulic Laying Clamp VZ-H-UNI

Artikel / Article	Beschreibung / Description	Best.-Nr. / Order-Number
Gummibacken Rubber grippers 	Gummibacken 60 x 25 x 100 mit Schrauben Rubber grippers 60 x 25 x 100 with screws	41600173
Lamelle Rib 	Lamelle mit Schrauben Rib with crews	41600172
Rolle Roller 	Rolle für Backe Roller for gripper	21860002
Manometer 	Manometer 250 bar	22130001
Handgriff Handle 	Handgriff rot 3/4" Handle red 3/4"	21600016
Ventilblock Valve block 	Ventilblock Valve block	22040015
Bolzen Bolt 	Bolzen mit Scheibe Backenbefestigung Bolt with disc gripper fixing	30300220





Betonschutzwandzange / Concrete Highway Divider Clamp BSZ-KH

Artikel / Article	Beschreibung / Description	Best.-Nr. / Order-Number
Handgriff Handle	 Handgriff rot Handle red	21600016
Oberlenker Side arm	 Oberlenker komplett mit Zeiger Side arm with indicator	27220006
Oberlenker Side arm	 Oberlenker komplett ohne Zeiger Side arm without indicator	27220005
Gelenklager Joint bearing	 Gelenklager GE35 Joint bearing GE35	21440004
Gummischiene Rubber track	 GMT Schiene weiss 110 x 31 x 220 mm (Bedarf: 8 Stück) GMT white track 110 x 31 x 220 mm (requirement: 8 units)	36350002
Gummischiene Rubber track	 GMT Gummischiene 60 x 15 x 200 mm (Bedarf: 2 Stück) GMT track 60 x 15 x 200 mm (requirement: 2 units)	36330110
Wechselautomatik Automatic changer	 Einsatz für Wechselautomatik Automatic changer insert	40110441
Wechselautomatik Automatic changer	 Spannstifte für Wechselautomatik 16 x 50 Spring pin 16 x 50	20530039
Wechselautomatik Automatic changer	 Spannstifte für Wechselautomatik 8 x 50 Spring pin 8 x 50	20530022



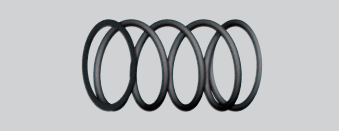

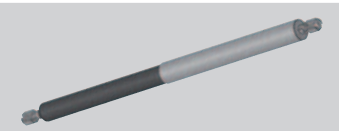





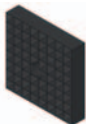

Rohrverlegedorn / Concrete Pipe Lifter RVD-4,5-ECO

Artikel / Article	Beschreibung / Description	Best.-Nr. / Order-Number
Bolzen Bolt 	Bolzen Federriegel Bolt for locking bar	30360002
Druckfeder Pressure spring 	Druckfeder 1,60x18,60 Pressure spring 1,60x18,60	21700011
Handhebel Handle 	Handhebel Federriegel Handle locking bar	31600008
Gasdruckfeder Gas pressure spring 	Gasdruckfeder Ø 14/40 Gas pressure spring Ø 14/40	21730018



Rohrgreifer / Round Grab RG-75/125-SAFELOCK, RG-100/150-SAFELOCK, RG-20/85-SAFELOCK

Artikel / Article	Beschreibung / Description	Best.-Nr. / Order-Number
Backen Grippers 	Stahlgreifpratte 60 x 60 x 15 Steelfinger gripper 60 x 60 x 15	34010108
Kette Chain 	Hochfeste Rundstahlkette, Meterware RG-75/125-SAFELOCK High-strength round steel chain, goods meter RG-75/125-SAFELOCK	21000110
Kette Chain 	Verbindungsglieder für Rundstahlkette RG-75/125-SAFELOCK Connecting links for round steel chain RG-75/125-SAFELOCK	21000014
Handkurbel Crank Handle 	Handkurbel ohne Stecknuss Crank Handle without Box nut	70690048
Stecknuss Box nut 	Stecknuss zu Handkurbel Box nut for Crank Handle	70690047
Kettenschloss Chain joint 	Kettenschloss mit Spintverschluss RG-20/85-SAFELOCK Chain joint with split pin RG-20/85-SAFELOCK	21000226
Kette Chain 	Einfache Rollenkette 29 Glieder RG-20/85-SAFELOCK Single roller chain 29 link RG-20/85-SAFELOCK	21000134
Gummischiene Rubber bar 	Gummischiene 60x15x200 RG-20/85-SAFELOCK Rubber bar 60x15x200 RG-20/85-SAFELOCK	43101377
Kette Chain 	Hochfeste Rundstahlkette, Meterware RG-100/150-SAFELOCK High-strength round steel chain, by metre RG-100/150-SAFELOCK	21000211
Kette Chain 	Verbindungsglieder RG-100/150-SAFELOCK Connecting links RG-100/150-SAFELOCK	21000344



Rohrgreifer / Round Grab RG-20/80

Artikel / Article	Beschreibung / Description	Best.-Nr. / Order-Number
Wechselautomatik Automatic changer 	Einsatz für Wechselautomatik Insert for automatic changer	40110040
Spannstift Spring pin 	für Wechselautomatik, DIN 1481, Dm 8 x 30 for automatic changer, DIN 1481, Dm 8 x 30	20530019
Spannstift Spring pin 	für Wechselautomatik, DIN 1481, Dm 16 x 30 for automatic changer, DIN 1481, Dm 16 x 30	20530038
Federriegel Spring lock 	Federriegel S22 S22 spring lock	20540022
Kettenschloss Chain lock 	Kettenschloss mit Federverschluss Chain lock with split pin fastening	21000226
Rollenkette Roller chain 	Einfache Rollenkette 680/9 Simple roller chain 680/9	21000134
Federriegel Spring lock 	Federriegel SG 15/14 SG 15/14 spring lock	20540033
Gummischiene Rubber track 	GMT 60 x 15 x 420 mm	36330146
Handgriff Handle 	Handgriff rot Handle red	21600016



Rohrgreifer / Round Grab RG-8/40

Artikel / Article	Beschreibung / Description	Best.-Nr. / Order-Number
Wechselautomatik Automatic changer 	Einsatz für Wechselautomatik Insert for automatic changer	40110040
Spannstift Spring pin 	für Wechselautomatik, DIN 1481, Dm 8 x 30 for automatic changer, DIN 1481, Dm 8 x 30	20530019
Spannstift Spring pin 	für Wechselautomatik, DIN 1481, Dm 16 x 30 for automatic changer, DIN 1481, Dm 16 x 30	20530038
Federriegel Spring lock 	Federriegel SG 15/14 SG 15/14 spring lock	20540033
Federriegel Spring lock 	Federriegel kompl. Verzinkt Spring lock compl. galvanized	20540024
Rollenkette Roller chain 	Einfache Rollenkette 680/9 Simple roller chain 680/9	21000251
Kettenschloss Chain lock 	Kettenschloss mit Federverschluss Chain lock with split pin fastening	21000081
Gummischiene Rubber track 	GMT 60 x 15 x 500 mm	36330027
Handgriff Handle 	Handgriff rot Handle red	21600002



Rundgreifer / Round grab RG-1,5/80

Artikel / Article	Beschreibung / Description	Best.-Nr. / Order-Number
Gummibelag Rubber	Gummibelag L = 300 Rubber L = 300	21010021
Gummibelag Rubber	Gummibelag L = 320 Rubber L = 320	21010022
Hebeband Lifting strap	Hebeband B = 200 Lifting strap B = 200	21010024
Hebeband Lifting strap	Hebeband B = 100 Lifting strap B = 100	21010025



Rundgreifer / Round grab RG-5/150

Artikel / Article	Beschreibung / Description	Best.-Nr. / Order-Number
Gummibelag Rubber	Gummibelag L = 390 Rubber L = 390	21010045
Gummibelag Rubber	Gummibelag L = 100 Rubber L = 100	21010046
Hebeband Lifting strap	Hebeband Tragkraft 6 t Lifting strap 6 to.	21010029
Hebeband Lifting strap	Hebeband Tragkraft 10 t Lifting strap 10 to.	21010032







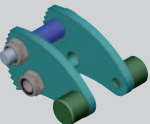

Schachtversetzzange / Manhole and Cone Installation Clamp SVZ-UNI

Artikel / Article	Beschreibung / Description	Best.-Nr. / Order-Number
Bolzen Bolt	 Bolzen mit Zapfen zu Pratte 2 Bolt with pin for claw 2	33320076
Abstreifring Wiper ring	 Abstreifring 50/55 50/55 wiper ring	21570053
Zahnsegment Gear segment	 Zahnsegment für Pratte 3 Gear segment for claw 3	33500683
Zahnsegment mit Bolzen Gear segment with bolt	 rechte Seite Right side	44000100
Zahnsegment mit Bolzen Gear segment with bolt	 linke Seite Left side	44000101
Gleitlager Slide bearing	 Gleitlager Mittelteil Set Slide bearing middle section set	44000056
Kette Chain	 Kettengehänge Tragkraft 3,15 t Chain hanger 3,15 t	21000185



Schachtversetzzange / Manhole and Cone Installation Clamp SVZ-UNI-VARIO

Artikel / Article	Beschreibung / Description	Best.-Nr. / Order-Number
Pratze Claw 	Stahlgreifpratze vormontiert unten Steelfinger gripper pre-installed bottom	44000039
Pratze Claw 	Stahlgreifpratze vormontiert oben inkl. Gegengewicht Steelfinger gripper pre-installed top incl. counterweight	44000038
Steckbolzen Pin bolts 	Steckbolzen mit Griff für Pratzen Pin bolts with grip for claws	44000052
Gleitlagersatz Slide bearing set 	Gleitlagersatz im Mittelteil Slide bearing set in middle section	44000056
Wechselautomat Automatic changer 	Einsatz für Wechselautomatik Insert for Automatic changer	40110042
Steckbolzen Pin bolts 	Steckbolzen für Schlitten Pin bolts for slides	44000169
Gleitführung Pin bolts for slides 	PE-Gleitführung für Schlitten PE-Sliding guide slides	36400387



Mechanischer Scherengreifer / Scissor Grab SG-80-PGL2/ SG-80-MAXI-PGL2

Artikel / Article	Beschreibung / Description	Best.-Nr. / Order-Number
Kette Chain	 Rundstahlkette 29 Glieder L: 610 für SG-80-MAXI-PGL2 Chain L: 610 for SG-80-MAXI-PGL2	21000153
Kette Chain	 Rundstahlkette 31 Glieder L: 651 für SG-80-PGL2 Chain L: 651 mm for SG-80-PGL2	21000245
Kette Chain	 Rundstahlkette 37 Glieder L: 770 für SG-80-PGL2 Chain L: 770 mm for SG-80-PGL2	21000246
Handgriff Handle	 Kunststoff Handgriff rot Plastic handle red	21600016
Gummibacke Rubber bar	 Gummibacke L: 1200 mm Rubber bar L: 1200 mm	36370018
Gummibacke Rubber bar	 Gummibacke L: 200 mm Rubber bar L: 200 mm	36370023
Gummibacke Rubber bar	 Gummibacke L: 60 mm Rubber bar L: 60 mm	36370022
Rad Wheel	 Polyamid Rad 125-40 Polyamid wheel 125-40	21800001







Kalksandsteinzange / Limestone Clamp KSZ-300-UNI

Artikel / Article	Beschreibung / Description	Best.-Nr. / Order-Number
Handgriff Handle	 klein, geriffelt 1/2" Small, ribbed 1/2"	21600005
Handgriff Handle	 mittel, geriffelt 3/4" Medium, ribbed 3/4"	21600016
Handgriff Handle	 groß, glatt 1" Large, smooth 1"	21600002
GMT Gummi GMT Rubber	 grau, 50 x 45 x 1000, Ausführung alt Grey, 50 x 45 x 1000, old design	36320032
6-Kant Schraube Hex head screw	 zu GMT Gummis For GMT rubbers	20000008
Schutznetz Protective netting	 für KSZ-300 for KSZ-300	45200010
Schutznetz Protective netting	 für KSZ-300-UNI for KSZ-300-UNI	55000012
Befestigung Fixing	 zu Schutznetz neu To new protective netting	45100044
Befestigung Fixing	 zu Schutznetz bei alter Ausführung To protective netting with old design	45100007
Profil-Gummi-Leiste Rubber strip profile	 1000 mm lang, grau 1000 mm long, grey	36370010

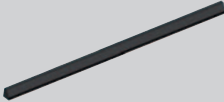

Dachelementzange / Roofing Element Clamp DEZ-UNI

Artikel / Article	Beschreibung / Description	Best.-Nr. / Order-Number
Einlegekorb Basket 	Einlegekorb 600 x 400 x 220 mm Inlay Basket 600 x 400 x 220 mm	45100037
Gummibacke Rubber bar 	GMT 40 x 35 x 1140 8 x M8 Gewinde Rubber bar GMT 40 x 35 x 1140 8 x M8 thread	36320127
Kette Chain 	Kette 26 Glieder L: 468 mit Verbindungsglieder Chain L: 468 mm with 2 connections	45200051
Handgriff Handle 	Kunststoff Handgriff 3/4" Plastic handle red 3/4"	21600016
Schutznetz Safety net 	Kastenschutznetz 1450 x 1450 x 650 mm Safety net 1450 x 1450 x 650 mm	55000012

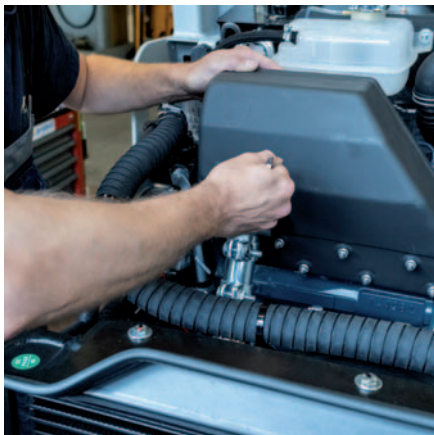

After Sales / Gewährleistung

Durch den Erwerb eines Probst-Produktes haben Sie sich für ein Qualitätsprodukt entschieden, dessen Entwicklung und Erprobung die Erfahrungen aus über 60 Jahren zugrunde liegen.

Für alle von uns hergestellten Neuteile übernehmen wir die Gewährleistung für 1 Jahr im Normalbetrieb, ½ Jahr im Schichtbetrieb soweit Material- oder Herstellungsfehler oder das Fehlen zugesicherter Eigenschaften nachgewiesen werden. Bei Gebrauchtteilen reduziert sich die Gewährleistung jeweils um die Hälfte. Davon ausgeschlossen sind Verschleißteile.

Sollte trotz Kontrollen einmal ein Fehler an Ihrem Probst-Produkt auftauchen, muss das gesamte Gerät, zusammen mit der Rechnung oder einem Lieferschein sowie einem ausgefüllten Rücklieferungsformular zu uns gesendet werden:

Probst GmbH

Technik Center
Gottlieb-Daimler-Str. 6
71729 Erdmannhausen
Tel. DE: + 49 7144 3309 10
Tel. AT/CH: + 49 7144 3309 30
E-Mail: service@probst-handling.de

Das Rücklieferungsformular finden Sie auf unserer Website www.probst-handling.de

Eine Ersatzteilübersicht finden Sie in der aktuellen Bedienungsanleitung welche mit der Auslieferung eines Probst Produktes ausgehändigt wurde. Bei Bedarf senden wir Ihnen diese gerne erneut zu.

Sollte die Reparatur außerhalb der Gewährleistung oder auf unsachgemäße Handhabung zurückzuführen sein, schicken wir Ihnen einen Kostenvorschlag mit der Bitte um Freigabe zu. Nachfolgend die Übersicht der Probst Servicebedingungen:

Service Leistung	Best.-Nr.	Preis in Euro
UVV Prüfung Probst Kleingeräte pauschal*	90010001	85,- *
UVV Prüfung Probst Großgeräte inkl. Probst Anbaugeräte*	90010002	160,- *
Prüfung für elektrische Arbeitsmittel nach VDE 0701-0702	90010020	30,- *
Fahrtkosten für Einsätze Service Techniker ¹⁾	90010009	1,15/km
Fahrtzeit ¹⁾	90010012	80,-/h
Arbeitszeit	90010011	80,-/h
Übernachungskosten Service Techniker	90010010	90,-/Nacht

¹⁾ Es wird nur die Anfahrt in Rechnung gestellt.

* Ohne Ersatzteile und eventuell anfallenden Reparaturkosten

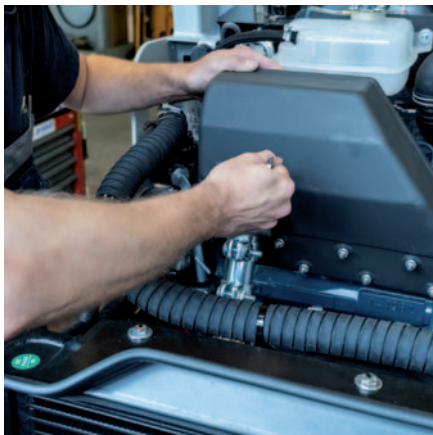

After Sales/Warranties

By purchasing a Probst product you have chosen a quality product which has been developed and tested as a result of over 60 years experience. We provide a 1-year warranty for normal use on all new components manufactured by us or a 6-month warranty for shift operation, provided there is evidence of material or manufacturing fault or that a warranted feature is missing. For used parts the warranty is reduced by half in each case. Wearing parts are excluded.

If, despite thorough controls, a fault should occur in your Probst product, the complete device should be sent to us, together with the invoice or delivery note and a completed returns form:

Probst GmbH

Technic Centre
Gottlieb-Daimler-Str. 6
71729 Erdmannhausen
Phone + 49 7144 3309 30
E-Mail: service@probst-handling.com

The returns form can be found on our website www.probst-handling.com

An overview of spares can be found in our current operating manual which is supplied with each Probst product. We are happy to send you another copy of this. If the repair is carried out after the warranty has expired or is due to improper handling, we will send you an estimate of cost together with a request for your approval. Overview of the Probst service terms and conditions:

Service provision	Order-Number	Price in Euro
UVV test Probst small appliances flat rate*	90010001	85,- *
UVV test Probst large appliances including Probst accessory*	90010002	160,- *
Inspection of electrical work equipment according to VDE 0701-0702	90010020	30,- *
Travelling expenses for service technician visit ¹⁾	90010009	1,15/km
Journey time ¹⁾	90010012	80,-/h
Working time	90010011	80,-/h
Overnight costs for service technician	90010010	90,-/Night

¹⁾ Only the journey will be charged.

* Without spare parts and any possible repair costs incurred

Die passenden Ersatzteile für jede Reparatur – hier in diesem Katalog, oder wir helfen Ihnen.

In diesem Katalog finden Sie viele Ersatzteile für Ihre Probst Maschinen, Geräte und Werkzeuge. Gerne helfen wir Ihnen bei der Auswahl. Für ein Angebot schicken Sie uns einfach dieses Anfrageformular. Übrigens: Mit der Probst Service-App kann Sie ein Probst-Techniker auch virtuell unterstützen.

Ansprechpartner: _____ Firma: _____

Telefon: _____ E-Mail Adresse: _____

Identifikation Probst-Gerät

Geräte-Bezeichnung

Gerätenummer / Seriennummer

Baujahr

Betriebsstunden (sofern vorhanden)

Artikelnummer

Identifikation Ersatzteil(e)

Beschreibung

Machen Sie bitte ein Foto von dieser Seite, und senden Sie diese an: service@probst-handling.de

Alternativ nutzen Sie unser Online-Formular und senden uns Ihre Anfrage digital zu:

www.probst-handling.com/de/service/ersatzteil-anfrage

Probst GmbH Tel. + 49 7144 3309 10, WhatsApp +49 176 43818017

Wir freuen uns über Ihre Anfrage und setzen uns umgehend mit Ihnen in Verbindung.

The right spare parts for every repair – here in this catalogue, or we can help you.

In this catalogue you find many spare parts for your Probst machines, devices and tools. We are happy to help you with your selection. For a quotation, simply send us this request form. By the way: With the Probst Service App, a Probst technician can also support you virtually.

Contact person: _____ Company: _____

Phone: _____ E-mail address: _____

Identification Probst device

Device name

Unit number / serial number

Year of manufacture

Operating hours (if available)

Order-Number

Identification spare part(s)

Description

Please take a photo of this page and send it to: service@probst-handling.de

Alternatively, use our online form and send us your request digitally:

<https://www.probst-handling.com/en/service/spare-parts-inquiry>

Probst GmbH Phone + 49 7144 3309 30, WhatsApp + 49 7144 3309 30

We are looking forward to your request and will contact you immediately.

1. Allgemeines

Die nachstehenden Bedingungen gelten für jeden Auftrag; sie schließen Einkaufsbedingungen des Käufers aus, auch wenn solchen nicht ausdrücklich widersprochen wird. Abweichende Vereinbarungen und nachträgliche Änderungen werden auf jeden Fall erst durch schriftliche Bestätigung gültig.

2. Angebot und Auftrag

Die zu dem Angebot gehörenden Unterlagen wie Abbildungen, Zeichnungen, Gewichts- und Maßangaben sind nur annähernd maßgebend, soweit sie nicht ausdrücklich als verbindlich bezeichnet sind. An Kostenvorschlägen, Zeichnungen und anderen Unterlagen behält sich der Verkäufer Eigentums- und Urheberrecht vor; sie dürfen Dritten nicht zugänglich gemacht werden. Der Verkäufer ist verpflichtet, vom Besteller als vertraulich bezeichnete Pläne nur mit dessen Zustimmung Dritten zugänglich zu machen. Aufträge und Vereinbarungen jeder Art werden erst mit der schriftlichen Bestätigung des Verkäufers rechtswirksam.

3. Preise

Die Preise verstehen sich ab Werk freibleibend, ausschließlich Verpackung. Verbindlich sind die Preise der Auftragsbestätigung, falls nicht wegen langen Lieferzeiten ein Preisvorbehalt unsererseits gemacht wird.

Es kommen die am Tage der Lieferung gültigen Preise zur Berechnung.

Zu den Preisen kommt die Mehrwertsteuer in der jeweiligen gesetzlichen Höhe hinzu. Für Aufträge mit einem Nettowarenwert bis EURO 50,- berechnen wir zusätzlich einen Mindermengenzuschlag von EURO 15,-.

4. Lieferung

Die vereinbarte Lieferzeit beginnt mit dem Datum der Auftragsbestätigung, jedoch erst nach Klärung aller Einzelheiten der Auftragsausführung. Höhere Gewalt, sowie unverschuldetes Unvermögen bei uns und unseren Lieferanten, insbesondere Verkehrs- oder Betriebsstörungen, Mangel an Material oder Zulieferteilen, berechtigen uns, angemessene Nachfristen zu beanspruchen.

Schadensersatzansprüche des Käufers wegen Nichterfüllung oder Verzug sind, außer im Fall unseres vorsätzlichen Verschuldens, ausgeschlossen.

Die Lieferfrist ist eingehalten, wenn bis zu Ihrem Ablauf der Liefergegenstand das Werk verlassen hat oder die Versandbereitschaft mitgeteilt ist. Wird der Versand auf Wunsch des Bestellers verzögert, so werden ihm, beginnend einen Monat nach Anzeige der Versandbereitschaft, die durch die Lagerung entstandenen Kosten, bei Lagerung im Werk des Verkäufers mindestens jedoch 1/2 v.H. des Rechnungsbetrages für jeden Monat berechnet. Die Einhaltung der Lieferfrist setzt die Erfüllung der Vertragspflichten des Bestellers voraus.

5. Verpackung, Versand, Gefahrübergang

Verpackungsart, Versandart und Versandweg bestimmt der Verkäufer, falls nicht eine gesonderte Vereinbarung getroffen wurde.

Der Versand geschieht auf Kosten und Gefahr des Käufers. Sofern keine besonderen Weisungen des Käufers erteilt werden, nehmen wir den Versand, auf dem nach unserem Ermessen besten Wege vor, ohne dass wir die Verantwortung für die billigste und kürzeste Verfrachtung übernehmen.

Jegliche Gefahr geht auf den Besteller über, sobald die Übergabe an den Spediteur oder Frachtführer erfolgt ist.

Eine Versicherung gegen Transportschäden erfolgt nur auf besondere Anordnung des Bestellers und wird auf jeden Fall in Rechnung gestellt.

Bei Versand durch die Bundesbahn oder einen Spediteur ist im Schadensfall der Entschädigungsantrag grundsätzlich vom Besteller selbst zu stellen. Die Fälligkeit unserer Zahlungsansprüche bleibt hiervon unberührt.

6. Vertragsgegenstand

Angaben des Verkäufers über Maße, Gewichte, Leistungen oder Material erfolgen sorgfältig, jedoch unverbindlich, soweit sie nicht ausdrücklich als verbindlich bezeichnet sind. Gleiches gilt für sämtliche Konstruktionsangaben und -vorschläge. Änderungen aufgrund der technischen Entwicklung behält sich der Verkäufer vor. Vom Verkäufer gefertigte Zeichnungen, Musterstücke und Unterlagen bleiben dessen Eigentum. Sie dürfen Dritten ohne dessen Einwilligung nicht zugänglich gemacht werden. Der Verkäufer weist insoweit auf sein Urheberrecht hin.

Die vertraglich geschuldeten Eigenschaften der Kaufsache richten sich ausschließlich nach unserer Produktbeschreibung und den schriftlichen Vereinbarungen. Einseitig vom Käufergeäußerte Vorstellungen bleiben ebenso außer Betracht wie Werbeaussagen und sonstige öffentliche Äußerungen des Verkäufers oder eines seiner Gehilfen.

Modelle, Werkzeuge und sonstige Einrichtungen für die Ausführung eines Auftrages bleiben, auch wenn der Verkäufer einen Anteil der Kosten berechnet, stets dessen Eigentum.

7. Gewährleistung

Sofern es sich nicht um unerhebliche Mängel handelt, leistet der Verkäufer unter Ausschluss weiterer Ansprüche für Mängel der Lieferung, zu denen auch das Fehlen ausdrücklich zugesicherter oder garantierter Eigenschaften gehört, Gewähr wie folgt:

Für alle von uns hergestellten Neuteile übernehmen wir die Gewährleistung für 1 Jahr im Normalbetrieb, 1/2 Jahr im Schichtbetrieb soweit Material- oder Herstellungsfehler oder das Fehlen zugesicherter Eigenschaften nachgewiesen werden. Bei Gebrauchteilen reduziert sich die Gewährleistung jeweils um die Hälfte. Die Gewährleistungsfrist beträgt 6 Monate beginnend mit der Lieferung. (Ausgeschlossen davon sind Verschleißteile).

Verzögert sich der Versand, die Aufstellung oder die Inbetriebnahme ohne Verschulden des Verkäufers, so erlischt die Haftung spätestens 18 Monate nach Gefahrenübergang.

Als Greifelemente eingesetzte Gummischienen sind Verschleißartikel und unterliegen nicht der Gewährleistung.

Mängel durch fehlerhafte Montage bzw. Inbetriebsetzung, ungeeignete oder unsachgemäße Verwendung oder Änderungen bzw. Instandsetzungsarbeiten durch den Käufer oder Dritte, natürliche Abnutzung, fehlerhafte oder nachlässige Behandlung, übermäßige Beanspruchung, ungeeignete Betriebsmittel, Austauschwerkstoffe, chemische, elektrochemische oder elektrische Einflüsse schließen jegliche Gewährleistung aus, sofern sie nicht auf ein Verschulden des Verkäufers zurückzuführen sind.

Weitergehende Rechte, insbesondere Ansprüche auf Ersatz von Schäden, die nicht an dem Liefergegenstand selbst entstanden sind, sind ausgeschlossen.

Mängelrügen innerhalb des vorstehend genannten Rahmens werden nur anerkannt, wenn sie binnen zwei Wochen nach Empfang der Ware, bei zunächst nicht erkennbaren Mängeln unverzüglich nach Kenntniserlangung durch schriftliche Erklärung geltend gemacht werden. Beanstandungen der Menge werden nur berücksichtigt, wenn sie sofort nach Erhalt der Sendung schriftlich vorgebracht werden. Die Untersuchungs- und Rügepflicht umfasst auch Bedienungs- und Montageanleitungen.

Ebenso müssen der Gewährleistung unterliegende Schäden unverzüglich schriftlich angezeigt werden. Ein Anspruch auf Wandlung oder Minderung besteht nicht, es sei denn, dass wir nicht in der Lage sind den Mangel zu beheben.

Zur Vornahme aller dem Verkäufer notwendig erscheinenden Ausbesserungen und Ersatzlieferungen hat der Besteller nach Verständigung mit dem Verkäufer die erforderliche Zeit und Gelegenheit zu geben, sonst ist der Verkäufer von der Mängelhaftung befreit.

Nur in dringenden Fällen der Gefährdung der Betriebssicherheit und zur Abwehr unverhältnismäßig großer Schäden, wobei der Verkäufer sofort zu verständigen ist, oder wenn der Verkäufer mit der Beseitigung des Mangels in Verzug ist, hat der Besteller das Recht, den Mangel selbst oder durch Dritte beseitigen zu lassen und vom Verkäufer Ersatz der notwendigen Kosten zu verlangen. Weitergehende Ansprüche, z.B. Ersatz von Lohn oder verdorbenem Material usw. sind ausgeschlossen. Ausbesserung oder Ersatz erfolgt nach unserer Wahl. Werden die Teile unfrei eingesandt so erfolgt die Rücksendung ebenfalls unfrei, d.h. ein Frachtweg wird von uns bei billiger Versandart getragen.

Die Gewährleistung erlischt, wenn der Liefergegenstand von fremder Seite bearbeitet wird, auch bei Zeitdruck setzt eine anderweitige Bearbeitung unser Einverständnis im Einzelnen voraus. Wir haften nicht für Mängel, die durch schlechte Montage durch den Besteller oder Dritte, durch schlechte Wartung oder Nachlässigkeit, durch ungeeignete oder unsachgemäße Verwendung oder durch übermäßige Beanspruchung entstanden sind.

Voraussetzung für die Gewährleistung ist die Erfüllung der vertraglichen Verpflichtungen durch den Käufer. Wegen Mängelrügen, über die kein Zweifel besteht, dürfen Zahlungen nur im angemessenen Verhältnis zu den aufgetretenen Mängeln zurückgehalten werden. Insbesondere dürfen keine Aufrechnungen gegen frühere oder spätere Lieferungen erfolgen. Rücksendungen bedürfen der vorherigen Zustimmung des Verkäufers.

8. Rücktrittsrecht des Käufers und sonstige Haftung des Verkäufers

Der Käufer kann vom Vertrag zurücktreten, wenn die gesamte Leistung vor Gefahrübergang endgültig unmöglich wird oder die Lieferung innerhalb einer angemessenen Frist, die einen Monat nicht unterschreiten darf, nicht erfolgte, es sei denn, das Leistungshindernis ist vom Verkäufer zumindest überwiegend zu vertreten oder es handelt sich um einen Fall der Ziff. 6. Absatz 4. Soweit Teilleistungen möglich und für den Käufer auch nach Beendigung des Vertrages im Übrigen verwertbar sind, beschränkt sich das Rücktrittsrecht auf die noch nicht geleisteten Teile. Tritt die Unmöglichkeit während des Annahmeverzugs oder durch Verschulden des Käufers ein, so bleibt dieser zur Gegenleistung verpflichtet. Sind bereits Teilleistungen im Sinne des Absatzes 1 erbracht, besteht auch insoweit ein Vergütungsanspruch. Der Käufer hat außerdem ein Rücktrittsrecht, wenn der Verkäufer eine ihm gestellte angemessene Nachfrist für die Behebung oder Nachbesserung eines vom Verkäufer zu vertretenden Mangels im Sinne der Lieferbedingungen durch dessen Verschulden fruchtlos verstreichen lässt. Entscheidet sich der Verkäufer für eine Nacherfüllung durch Beseitigung des Mangels, hat der Käufer ein Rücktrittsrecht erst, wenn die Beseitigung des Mangels zweimal fehlgeschlagen ist. Die angemessene Nachfrist beginnt nicht eher, als bis der Mangel und die Vertretungspflicht des Verkäufers feststehen und nachgewiesen sind. Der Käufer kann statt seines Rücktrittsrechts auch Minderung geltend machen.

Nimmt der Käufer oder ein Dritter unsachgemäß ohne vorherige Genehmigung des Verkäufers Änderungen oder Instandsetzungsarbeiten vor, entfällt eine Haftung des Verkäufers für die daraus entstehenden Folgen.

Die Haftung des Verkäufers richtet sich ausschließlich nach den in den vorstehenden Ziffern getroffenen Vereinbarungen. Alle dort nicht ausdrücklich zugestandenen Rechte z.B. auf Lieferung einer mangelfreien Sache, Rücktritt vom Vertrag oder Minderung sowie auf Ersatz von Schäden jeder Art, und zwar auch von solchen Schäden, die nicht am Liefergegenstand selbst entstanden sind und gleich aus welchem Rechtsgrund, sind ausgeschlossen. Dieser Haftungsausschluss gilt nicht bei Vorsatz und grober Fahrlässigkeit von gesetzlichen Vertretern oder Erfüllungsgehilfen und bei schuldhafter Verletzung von Kardinalpflichten. Der Haftungsausschluss findet weiter keine Anwendung bei Fehlen von Eigenschaften, die ausdrücklich zugesichert sind, wenn die Zusicherung gerade bezweckt hat, den Käufer gegen Schäden, die nicht im Liefergegenstand selbst entstanden sind, abzusichern sowie wenn der Schaden auf einem Umstand beruht, für den der Verkäufer eine Garantie übernommen hat. Gleiches gilt, wenn sich ein Beschaffungsrisiko realisiert, das der Verkäufer ausdrücklich übernommen hat. Schließlich gilt der Haftungsausschluss nicht in den Fällen, in denen nach dem jeweils geltenden Landesrecht eine Schadenersatzpflicht besteht, die vertraglich nicht ausgeschlossen werden kann, insbesondere für Produkthaftung. Außer bei Schäden für Leben, Körper und Gesundheit und für Vorsatz und grobe Fahrlässigkeit von gesetzlichen Vertretern und Erfüllungsgehilfen, beschränkt sich der Umfang des zu ersetzenden Schadens aber auf vorhersehbare Schäden.

9. Zahlung

Zahlungsort und Währung werden gesondert vereinbart.

Eine Zurückbehaltung der Zahlung oder eine Aufrechnung ist nur wegen/mit unbestrittenen oder rechtskräftig festgestellten Gegenansprüchen zulässig.

Verschlechtert sich die Vermögenslage des Käufers nach Vertragsabschluss wesentlich und wird dadurch der Gegenleistungsanspruch des Verkäufers gefährdet, ist der Verkäufer berechtigt, die Leistung zu verweigern, bis die Gegenleistung bewirkt oder Sicherheit für sie geleistet wird.

10. Zahlungsverzug

Hält der Käufer die vereinbarte Zahlungsfrist nicht ein, berechnen wir ab Fälligkeit Zinsen in der nach deutschem Recht gesetzlich vorgesehenen Höhe. Vor Bezahlung fälliger Beträge ist der Verkäufer zu keiner weiteren Lieferung verpflichtet, soweit der Käufer hierfür nicht Sicherheit leistet. Bei vom Käufer verschuldetem Ausbleiben einer fälligen Zahlung werden sämtliche offenen Rechnungen des Verkäufers sofort fällig.

11. Eigentumsvorbehalt

Bis zur vollständigen Befriedigung sämtlicher Ansprüche aus der Geschäftsverbindung bleiben die gelieferten Waren Eigentum des Verkäufers. Der Käufer hat die Ware ordnungsgemäß aufzubewahren und zu versichern. Verspätet sich der Käufer mit fälligen Zahlungen um mehr als 10 Werktagen ist der Käufer auf Verlangen des Verkäufers zur Herausgabe der gelieferten Ware verpflichtet, ohne dass der Verkäufer zuvor den Rücktritt vom Vertrag erklären muss.

12. Annahme, Abruf, Rücktrittsrecht des Verkäufers

Auf Abruf gekaufte Waren sind binnen einem Monat nach Aufforderung zur Abnahme anzunehmen.

Befindet sich der Käufer in Annahmeverzug, kann der Verkäufer die Ware auf Kosten und Gefahr des Käufers einlagern und alle daraus entstehenden Kosten in Rechnung stellen. Das gleiche gilt, wenn aufgrund von Umständen, die der Käufer zu vertreten hat, versandfertige Waren nicht versendet werden können.

Befindet sich der Käufer trotz Fristsetzung weiter im Annahmeverzug, befindet er sich mit einer fälligen Zahlung mehr als 30 Tage im Verzug oder begeht der Käufer eine andere schwerwiegende Vertragsverletzung, ist der Verkäufer zum Rücktritt vom Vertrag und zur Geltendmachung des Schadenersatzes berechtigt.

13. Schiedsgericht, Erfüllungsort, Sonstiges

Die Rechte des Käufers sind nicht übertragbar.

Die rechtliche Unwirksamkeit oder Änderung einzelner Bestimmungen berühren die Gültigkeit der übrigen Bestimmungen nicht. An die Stelle einer unwirksamen Bestimmung soll diejenige zulässige Regelung treten, die dem wirtschaftlichen Gedanken der unwirksamen Bestimmung am nächsten kommt.

Erfüllungsort für alle Lieferungen ist das Lieferwerk des Verkäufers, in Erdmannhausen, soweit keine abweichende Vereinbarung getroffen worden ist. Die vorstehenden Bedingungen gelten für jeden Auftrag. Andere Bedingungen sind für den Verkäufer nur bindend, wenn er sie schriftlich anerkannt haben.

Auf den Vertrag ist das Recht der Bundesrepublik Deutschland unter Ausschluss des Übereinkommens der Vereinten Nationen vom 11.04.1980 über Verträge über den internationalen Warenkauf anwendbar.

Alle Streitigkeiten, die sich im Zusammenhang mit dem Vertrag oder über seine Gültigkeit ergeben, werden nach der Schiedsgerichtsordnung der Deutschen Institution für Schiedsgerichtsbarkeit e.V. (DIS) unter Ausschluss des ordentlichen Rechtswegs endgültig entschieden. Das Schiedsgericht kann auch über die Gültigkeit dieser Schiedsvereinbarung bindend entscheiden.

1. Preamble

The conditions stated in the following are valid for each order; they exclude the conditions of the Purchaser even if not contradicted expressly. Other Agreements and later modifications are in any case only valid by written confirmation.

2. Offer

All documents belonging to the offer like drawings, indications of weights and measures constitute an approximate guide. The data shall not be binding save to the extent that they are by reference expressly included in the offer. Any drawings or technical documents as well as preliminary quotations and other documents remain the exclusive property of the Vendor. These confidential documents may not, without the Vendors consent, be utilized by the Purchaser or copied, reproduced, transmitted or communicated to a third party. Orders and agreements of all kind need the written confirmation by the Vendor.

3. Prices

The prices are quoted ex works, packing excluded, without engagement. The prices stated in the order-confirmation are fixed, except there are agreed free prices due to long delivery times.

Invoiced will be the prices which are valid on the date of delivery.

4. Delivery

The agreed delivery time starts with the date of order-confirmation, however only if all details regarding the execution of the order will be clarified. Acts of God and other circumstances which are beyond the control of us and of our suppliers like transport disturbances or operating breakdown, lack of material or of parts from suppliers authorize us to claim an adequate extended term.

Purchaser's claims for damages due to failure to perform or delay are excluded if we are not willfully responsible for the damage.

The term of delivery is kept when the product has left the works or it is advised ready for dispatch within the agreed time.

Should delay in delivery be caused by the Purchaser, he will be charged for each month with at least 1/2% of the total invoice amount beginning one month after dispatch date thus covering the costs which arise by storage in the Vendor's works.

The fulfilment of contract by the Purchaser is a precondition for the keeping of delivery times by the Vendor.

5. Packing, Transport, Risk

The kind of packing, way of despatch and shipping route is determined by the Vendor except if there is a special previous agreement.

The costs and risks for the transport of the goods are to be borne by the Purchaser. Provided that no other instructions are given by the Purchaser, we organize the transport by the way that seems best to us without taking responsibility for having chosen the utmost favourable and shortest way.

The Purchaser bears every risk as soon as the merchandise is handed over to the transport agent or carrier.

An insurance against transport damages will only be effected if it is expressly desired by the Purchaser and the costs will be invoiced to him.

In case of transport through the Federal Railway Company or a forwarding agent the Purchaser has to take care of the settlement of his claim by himself.

The maturity for our request of payment is not affected.

6. Subject of Contract

The statements regarding measurements, weights, material and services are carefully stated by the Vendor however not binding, except they are expressly determined to be binding. This is also concerning all statements on construction and suggestions for construction. The Vendor reserves the right for modifications due to technical progress. Any drawings, samples or documents of the Vendor remain the exclusive property of the Vendor. They may not without the Vendor's consent be passed on to a third party. This is to point out the Vendor's copyright. The contractual characteristics of the goods are only relating to our product-description and to the written agreements.

Unilateral expectations of the Purchaser as well as advertisements or other comments of the Vendor or his assistants are not taken into consideration.

Demonstration-products, tools and other equipment needed for the execution of an order, remain the Vendor's property, even if the Vendor partially invoices the costs.

7. Guarantee

Provided that it is not about insignificant fault, the Vendor performs under exclusion of other claims for faults of the delivery to which belongs also the absence of strictly guaranteed or guaranteed qualities, guarantee as follows: for all brand new parts produced by us we take over the guarantee for 1 year in the normal use, 1/2 year in the shift work so far material defects or production mistakes or the absence of guaranteed qualities are proved. For used parts the warranty is reduced by half in each case. The warranty period is 6 months commencing with delivery (Wearing parts are excluded). If the dispatch, the installation or the introduction is delayed without fault of the Vendor, the liability expires not later than 18 months after transmission of risk. Rubber bars used as gripping elements are wear articles and are not subject to the guarantee. Faults by incorrect assembly or initial start-up, unsuitable or inappropriate use or changes or repairs by the Purchaser or third persons, natural wear, incorrect or careless treatment, excessive strain, unsuitable methods of operation, exchange materials, chemical, electro-chemical or electric influences expels every guarantee, provided that they are not to be led back on a fault of the Vendor. Further rights, particularly claims to substitute of the losses which have not appeared in the subject of delivery themselves, are expelled.

Notices of defect within the above stated frame are only recognized if they are asserted within two weeks after reception of the goods, with first not recognizable fault immediately after knowledge by written statement. Objections on the amount are only considered if they are brought forward immediately on receipt of the consignment in written form. The examination and reprimand obligation also encloses operating instructions and assembly instructions.

Also damages which are subject to the guarantee have to be indicated immediately in writing. A claim to transformation or decrease does not exist, unless we are not able the lack to repair. To the realization of all repairs inevitably appearing to the Vendor and substitute deliveries the customer after communication with the Vendor has to give the required time and opportunity, otherwise the Vendor is freed from the liability for defects.

Only in pressing cases of the endangering of the operational safety and to avoid disproportionately big losses, whereby the Vendor is to be informed immediately, or if the Vendor is in delay with the removal of the lack, the customer has the right to allow to remove the lack by third persons and has a claim for reimbursement of wasted expenditure towards the Vendor. Further claims, e.g., substitute of wage or spoiled equipment, etc., are expelled.

Repair or substitute is our choice. If the parts are returned not free of charge so they will be sent back also not free, i.e. a freight way is carried by us with the cheapest way of dispatch.

The guarantee expires if the subject of delivery is treated by foreign party, also with pressure of time an other treatment needs our consent in particular. We are not responsible for failures as a result of bad assembly by the customer or third persons, of bad maintenance or carelessness, of unsuitable or inappropriate use or of excessive use.

Precondition for the guarantee is the fulfillment of the contractual obligations by the Purchaser. Because of the notices of defect about which no doubt exists, payments may be held back only in the appropriate relation to the appeared lack. Particularly no compensations may take place against earlier or later deliveries. Returns need the previous agreement of the Vendor.

8. Right to rescind of the Purchaser and other liability of the Vendor

The Purchaser can withdraw from the contract if the whole performance is definitively impossible before risk transfer or the delivery within an appropriate term which may not remain under a month, did not take place, unless, the performance hindrance is to be represented from the Vendor at least mainly or it is about a case of point 6. paragraph 4. As far as partial performances are possible and for the Purchaser useful also after ending of the contract, the right to rescind limits itself to the parts not yet performed.

If the impossibility enters during the acceptance delay or by fault of the Purchaser, he remains obliged to do the settlement. If partial performances have already taken place for the purposes of the paragraph 1, a compensation claim also exists in this respect. The Purchaser has furthermore a right to rescind if the Vendor has passed inactively an adequate extension placed to him for the repairing or reworking due to a failure to be represented by the Vendor in the sense of these terms of delivery. If the Vendor decides on an extended elimination of the lack, the Purchaser only has a right to rescind if the elimination of the lack has failed two times. The appropriate extension does not begin earlier, than the lack and the representation obligation of the Vendor are determined and proved. The Purchaser can also assert reduction instead of his right to rescind. If the Purchaser or a third person makes inappropriate changes or repairs without previous approval of the Vendor, there is no liability of the Vendor for the consequences appearing from it.

The liability of the Vendor is determined exclusively according to the preceding points of this agreement. All not strictly admitted rights there, e.g., on delivery of a faultless product, resignation of the contract or decrease as well as on substitute of losses of every kind, namely also from such losses which have not appeared in the subject of delivery and regardless of any legal argument, are excluded. This exclusion of liability applies not with intention and gross negligence of legal representatives or fulfillment assistants and by culpable violation of main liability. The exclusion of liability finds no further application if qualities which are strictly guaranteed are missing, if the warranty has just aimed to safeguard the buyer against the losses which have not appeared in the subject of delivery themselves, as well as if the damage is based on a circumstance, for which the Vendor has taken over a guarantee. The same applies if a procurement risk realizes which the Vendor has explicitly taken over. Finally, the exclusion of liability applies not in that cases in which according to the country right valid in each case a damages obligation exists which can not be expelled by contract, particularly for product liability. Except for losses for life, body and health and for intention and coarse negligence of legal representatives and fulfillment assistants, the extent of the damage to be replaced is limited however, on foreseeable losses.

9. Payment

The setting place for payment and the currency are agreed especially.

A delay in payment or a setting off is only acceptable in case of undisputed or legally binding counter-claims.

If the financial situation of the Purchaser gets worse after agreement to the contract essentially and is thereby endangering the payment entitled to the Vendor, the Vendor is entitled to refuse the performance, until the settlement is effected or is performed safety for him.

10. Delay in Payment

If the Purchaser does not keep to the arranged term of payment, we charge from maturity for interests by the legal height according to German law. Before payment of payable amounts the Vendor is not obliged to do any other delivery, as far as the Purchaser does not perform safety for this. In case of outstanding overdue payment, indebted by the Purchaser, all unpaid invoices of the Vendor become immediately payable.

11. Retention of title of ownership

Up to entire satisfaction of all claims from the business connection remain the supplied goods property of the Vendor. The Purchaser has to keep the goods duly and to insure them. If the Purchaser is late with payable payments in more than 10 workdays the Purchaser is obliged on demand of the Vendor to return the supplied goods, without the Vendor must explain before the withdrawal of the contract.

12. Acceptance, call, right to rescind of the Vendor

On call bought goods are to be accepted within a month after demand to takeover. If the Purchaser is in acceptance delay, the Vendor can store the goods at the expenses and risk of the Purchaser and can invoice him all expenses appearing from it. The same applies if due to circumstances attributed to the Purchaser, goods ready for dispatch can not be dispatched. If the Purchaser continues to delay acceptance of the goods in spite of passed time-limit, is a payable payment more than 30 days in the delay or commits the Purchaser another weighty breach of the contract, the Vendor is entitled to the withdrawal of the contract and to claim for damages.

13. Arbitration board, place of delivery, other rights

The rights of the Purchaser are not transferable.

The legal ineffectiveness or change of single regulations do not touch the validity of the rest regulations.

To the place of an ineffective regulation that permissible regulation should step which comes to the economic thought of the ineffective regulation in the next. Place of delivery for all deliveries is the manufacturing work of the Vendor, in Erdmannhausen, as far as no divergent agreement has been met. The preceding conditions apply to every order. Other conditions are for the Vendor only bindingly if he has recognized them in writing.

On the contract the right of the Federal Republic of Germany is applicable under exclusion of the agreement of the United Nations from the 11/04/1980 about contracts about the international goods purchase.

All disputes which arise in connection with the contract or about its validity, are decided according to the arbitration board order of the German Institution for Arbitration Board Ability Inc (DIS) under exclusion of the neat course of law finally. The arbitration board also can make a binding decision about the validity of this arbitration agreement.



making hard work easier

Probst GmbH
Gottlieb-Daimler-Straße 6
71729 Erdmannhausen
+49 7144 3309-10
info@probst-handling.com

www.probst-handling.com